



03

lumi / lights



La Riccardo Barthel è un'azienda fiorentina specializzata nella progettazione e nell'arredamento d'interni che da quarant'anni rappresenta uno stile ben preciso, unico e inconfondibile: lo stile Barthel.

Oggi la passione di padre e figlio unita alla maestria e alle capacità di architetti ed esperti artigiani, muove l'azienda alla ricerca dell'eccellenza e della perfezione. La cura per i dettagli, l'amore per il restauro e l'originalità nella progettazione, sono le qualità che caratterizzano le realizzazioni Barthel, apprezzate da una clientela raffinata che ne diventa portavoce in Italia e nel mondo.

Riccardo Barthel is a Florentine company specialized in interiors design and décor, representing for over forty years a very specific style, unique and distinct: the Barthel style.

Today the passion of both father and son, together with the finesse and the skills of architects and artisans, lead the company to excellence and perfection. A keen eye for details, the love for restoration and the brilliant designs, are the key to Barthel's realizations, appreciated by a fine clientele both in Italy and worldwide.



non e
zuppa e
BAGNATO

L'APPETITO
vien mangiando

una
MELA
al giorno leva il
MEDICO
di torr
se non e
zuppa e
PANBAGNATO

VINO
VERITAS



quant
arriv
MINERA
nor
desa
SINRA
PAND'UN
al contadino
non far sapere
quanto è buono
IL CACIO CON LE PERE
quando
arriva la
MINESTRA
non c'è
destra nè
SINISTRA

al contadino
non far sapere
quanto è buono
IL CACIO CON LE PERE

TUTTO
FA
BRODO

L'APP
vi
MANG

una
MELA
al giorno leva il
MEDICO
di torno

al con
non far sapere
quanto è buono
IL CACIO CON LE PERE

arriva la
MINESTRA
non c'è
destra nè
SINISTRA
PAND'UN

PARLA
COME

PIATTO
ricco mi ci
FICCO



MANGI

GRAPPINI
e caffè fermati
A TRE

quando
arriva la
MINESTRA
non c'è
destra nè
SINISTRA
IL CACIO CON LE PERE

storia	history	6
lavorazione	processing	9
composizione codice articolo	identification codes of articles	11
legenda simboli	symbol legend	13
finiture	core finishes	14
appliques	wall lamps	18
plafoniere	ceilings	48
lanterne	lantern	60
lampadari	chandelier	64
piantane	floor lamps	70
lampade da tavolo	table lamps	74
lumi da esterno	outdoor lamps	78
accessori	accessories	80



Fondata in Via dei Fossi nel 1976 da Riccardo Barthel per dare voce alla sua creatività, da piccola azienda diventa presto una realtà con 30 collaboratori pur conservando la sua tipica atmosfera di piacevole familiarità. Nel 1994 la Riccardo Barthel si trasferisce nell'oltrarno fiorentino riunendo lo studio di progettazione, i laboratori e lo showroom all'interno di un unico luogo di grande stile, mettendo a disposizione del cliente professionalità diverse. Dal 2001, la sede di Forte dei Marmi, realizzata in un ex rimessaggio di barche, affianca quella di Firenze. Una delle anime più forti dell'azienda e che ha concorso a renderla celebre è la divisione Brocante, la continua ricerca di pezzi unici, segnati dal tempo, che grazie al sapere degli artigiani vengono restaurati o rivisitati in chiave contemporanea.

Riccardo Barthel sviluppa il proprio campo operativo fino a specializzarsi nella progettazione e nell'esecuzione di arredamenti chiavi in mano per abitazioni private, alberghi, ristoranti e negozi. Dal 2003 l'azienda si dedica alla realizzazione di attrezzature ed elementi di arredo e alla riproduzione di modelli originali destinati alle imbarcazioni storiche e di nuova costruzione. I risultati eccellenti sono frutto dell'abilità di anticipare le tendenze e della bravura dell'equipe di progettisti e artigiani che operano in totale sinergia.

La vocazione di Riccardo Barthel alla cura per i dettagli e la conoscenza delle tecniche tradizionali portano alla realizzazione di una propria linea di accessori, maniglie e lumi. I prodotti si fondono perfettamente negli ambienti Barthel, rispettando i canoni del suo stile: l'eleganza discreta, dettata dalla pulizia delle linee, i materiali ricercati, e il carattere senza tempo di ogni oggetto.



Founded in 1976 in Via dei Fossi by Riccardo Barthel to speak its own creativity, from a small company it soon becomes a reality of over 30 collaborators, strongly keeping its typical familiar atmosphere. In 1994 Riccardo Barthel moves to the Florentine Oltrarno, gathering the design studio, the laboratories and the showroom in a single place of unique style, hence offering to clients multiple expertise. In 2001, a new space is open inside an ex-boatyard in Forte dei Marmi. One of the strongest specialty, that has also contributed to make the company acclaimed, is the Brocante division, the continuous research of uniquely aged pieces, that are restored or renovated by the artisanal experience.

Riccardo Barthel develops its operating field to specialize in the design and development of turnkey projects for private houses, hotels, restaurants and shops. Since 2003 the company operates in the realization of equipment, interior fittings and in the reproduction of original models for classic and new yachts. Excellence is the result of the ability to anticipate trends and of the reciprocity between designers and artisans.

Riccardo Barthel care for details and artisanal knowledge lead to the creation of an inhouse line of accessories, handles and lights. The products perfectly melt within Barthel environments, respecting its style code: the fine lines, the sought-after materials and the timeless nature of the objects.





Realizziamo i nostri prodotti attraverso la lavorazione e la trasformazione del legno e dei metalli, principalmente dell'ottone, utilizzando le tecniche di tornitura, di tiratura, di incisione e di fusione. I prodotti Riccardo Barthel sono unici e riconoscibili e portano con sé il marchio secolare della pratica artigiana fiorentina. Le lavorazioni meccaniche ad alta precisione ed i manufatti in legno, vetro e ceramica, portano alla realizzazione sia di ambienti che conservano la tradizione, sia di ambienti contemporanei e funzionali per soddisfare le esigenze e le passioni dei nostri Clienti.

We make our products manufacturing and transforming woods and metals, mainly brass, using turning, hammering, engraving and casting techniques. Riccardo Barthel products are unique and distinctive, bearing the centuries-old stamp of Florentine craftsmanship. The high-precision mechanical processing and the produces in wood, glass and ceramics enable us to create both traditional and contemporary environments to fulfil the needs and passions of our Clients.



02

NUMERAZIONE
CATALOGO
CATALOGUE
NUMBER

APP

TIPOLOGIA
PRODOTTO
PRODUCT

001

NUMERAZIONE
ARTICOLO
ARTICLE
NUMBER

S

DIMENSIONE
ARTICOLO
ARTICLE
SIZE

NI*

SIGLA
FINITURA
FINISH

* il codice articolo completo di sigla finitura compare esclusivamente nel listino prezzi ed è necessario per compilare ordini e richieste di preventivo.

The finishing code it is only shown in the price list and it is necessary to both quote requests and orders.

TIPOLOGIA PRODOTTO/PRODUCT TYPE IDENTIFICATION

APP	appliques	wall lamps
PLA	plafoniere	ceilings
LAN	lanterne	lanterns
LAM	lampadari	chandeliers
PIA	piantane	floor lamps
LDT	lampade da tavolo	table lamps
LDE	lumi da esterno	outdoor lamps
ACC	accessori	accessories

DIMENSIONE/SIZE

U	universale	universal
S	piccola	small
M	media	medium
L	grande	large
XL	extralarge	extralarge

NOTA/NOTE

Tutti i lumi sono da intendersi forniti senza il paralume, salvo diversamente specificato.

All the lamps shall be supplied without lampshade, unless otherwise specified.





Tipo di attacco

Type of lamp cap

NL

Numero di lampade

Numbers of lamps in use by the object

W_{max}

Numero massimo di Watt supportati

Maximum Watt power

Led

Prodotto a Led

Led product

W_{Led}

Watt Led

Watt Led

K°

Temperatura di colore espressa in gradi Kelvin
3000° K luce calda
4000° K luce fredda

Light temprature expressed in Kelvin degrees
3000° K warm white
4000° K cool white

V

Volts

Volts

TABELLA CONVERSIONE WATTAGGIO - CONVERSION TABLE

Incandescenza tradizionale - Standard	25W	40W	60W	75W	100W
Lampada Alogena - Halogen	18W	28W	42W	53W	70W
Lampada risparmio energetico - CLF	6W	9W	12W	15W	20W
Lampada a LED - LED	4W	6W	10W	13W	18W

ON



OTTONE NATURALE
BRASS

OV



OTTONE VERNICIATO
LAQUER BRASS

OB



OTTONE BRUNITO
AGED BRASS

NL



NICHEL LUCIDO
POLISHED NICKEL

NI



NICHEL INVECCHIATO
AGED NICKEL

NS



NICHEL SATINATO
SANDED NICKEL

NSV



NICHEL SABBIATO VERNICIATO
MATTE NIKEL

CL



CROMO LUCIDO
CHROME

CSV



CROMO SABBIATO VERNICIATO
MATTE CHROME

AL



ARGENTO LUCIDO
SHINY SILVER

ASV



ARGENTO SABBIATO VERNICIATO
AGED SILVER

NELV



NERO LUCIDO VERNICIATO
SHINY BLACK

<input type="radio"/>	<input type="radio"/>	<input type="radio"/>
on	ov	ob
<input type="radio"/>	<input type="radio"/>	<input type="radio"/>
nl	ni	ns
<input type="radio"/>	<input type="radio"/>	<input type="radio"/>
nsv	cl	csv
<input type="radio"/>	<input type="radio"/>	<input type="radio"/>
al	asv	nelv
<input type="radio"/>	<input type="radio"/>	<input type="radio"/>
nesv	olv	osv

NESV



NERO SABBIATO VERNICIATO
MATTE BRONZE

OLV



ORO LUCIDO VERNICIATO
GOLD

OSV



ORO SABBIATO VERNICIATO
MATTE GOLD

Per ogni articolo la campitura grigia indica la disponibilità della finitura.

The grey field means that the item is available in a particular finish.

ON	La superficie risulta lucida, lasciata senza nessun tipo di protezione che impedisca il naturale processo di ossidazione. Surface looks initially polished but has no protection against the natural oxidation process.
OV	La superficie risulta lucida e protetta da una vernice trasparente che preserva nel tempo le caratteristiche estetiche. Shiny finish with protective coating of transparent varnish.
OB	La superficie viene sottoposta ad un trattamento di ossidazione che conferisce all'articolo una colorazione marrone scuro ed una finitura semilucida. Oxidized, dark brown with semi-shiny finish.
NL	La superficie viene sottoposta ad un trattamento galvanico e risulta lucida di colore metallico tendente leggermente al giallo. Oxidized, dark brown with semi-shiny finish.
NI	La superficie viene sottoposta ad un trattamento di ossidazione che conferisce all'articolo una colorazione grigio blu ed una finitura semilucida. Oxidized blue gray, with semi-shiny finish.
NS	La superficie viene satinata manualmente e poi sottoposta ad un trattamento galvanico che conferiscono all'articolo una finitura semilucida. Hand-brushed and electroplated semi-shiny finish.
NSV	La superficie viene sottoposta ad un trattamento galvanico, risulta opaca di colore grigio caldo e protetta da una vernice trasparente che preserva nel tempo le caratteristiche estetiche. Matte, warm gray electroplated finish with protective coating of transparent varnish.
CL	La superficie viene sottoposta ad un trattamento galvanico e risulta lucida di colore metallico tendente leggermente al blu. Shiny, slight blue-toned metallic electroplated finish.
CSV	La superficie viene sottoposta ad un trattamento galvanico, risulta opaca di colore grigio freddo e protetta da una vernice trasparente che preserva nel tempo le caratteristiche estetiche. Matte, cool gray electroplated finish with protective coating of transparent varnish.
AL	La superficie risulta lucida, lasciata senza nessun tipo di protezione che impedisca il naturale processo di ossidazione. Surface looks initially polished but has no protection against the natural oxidation process.
ASV	La superficie viene sottoposta ad un trattamento galvanico, risulta opaca e protetta da una vernice trasparente che preserva nel tempo le caratteristiche estetiche. Matte, electroplated finish with protective coating of transparent varnish.
NELV	La superficie viene sottoposta ad un trattamento galvanico, risulta lucida di colore canna di fucile e protetta da una vernice trasparente che preserva nel tempo le caratteristiche estetiche. Shiny, electroplated gunmetal finish with protective coating of transparent varnish.
NESV	La superficie viene sottoposta ad un trattamento galvanico, risulta opaca di colore canna di fucile e protetta da una vernice trasparente che preserva nel tempo le caratteristiche estetiche. Matte, electroplated gunmetal finish with protective coating of transparent varnish.
OLV	La superficie viene sottoposta ad un trattamento galvanico, risulta lucida e protetta da una vernice trasparente che preserva nel tempo le caratteristiche estetiche. Shiny, electroplated finish with protective coating of transparent varnish.
OSV	La superficie viene sottoposta ad un trattamento galvanico, risulta opaca e protetta da una vernice trasparente che preserva nel tempo le caratteristiche estetiche. Matte, electroplated finish with protective coating of transparent varnish.

Le misure sono in centimetri ed in pollici.*
The measurements are in centimeters and inches.*

FxG	borchia/base	boss/base axes
ØB	borchia/base	boss/base diameter
L	larghezza	width
H	altezza	height
H _{min}	altezza min	minimum height
H _{max}	altezza max	maximum height
Ag	aggetto	overhang
RI	raggio ingombro	maximum overall dimension
ØI	ingombro	overall dimension
RxS	ingombro	overall dimension
ØZ	bocca	opening
Ø _{inf}	dimensione inferiore	lower dimension
Ø _{sup}	dimensione superiore	upper dimension
PxQ _{inf}	dimensione inferiore	lower dimension
PxQ _{sup}	dimensione superiore	upper dimension
d	diagonale	diagonal

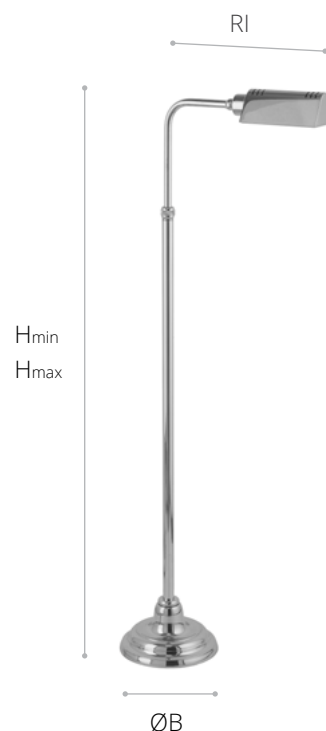

* I lumi estensibili sono misurati nella posizione ritenuta più corretta.
Le dimensioni degli articoli comprendono paralumi, ventole o vetri.

* Extensible lamps are measured in the position considered to be most correct.
The dimensions of the articles include lampshades, shades and glass parts..

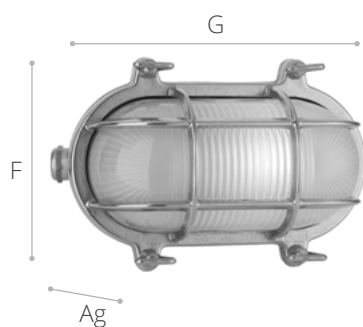
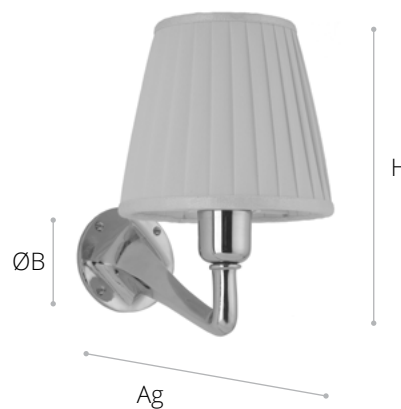

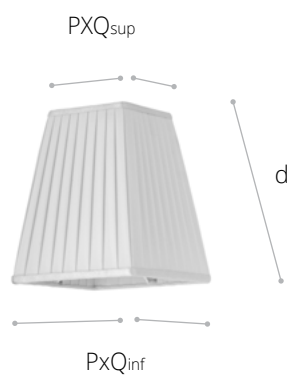
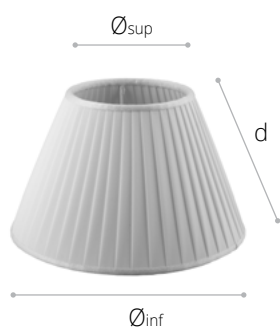
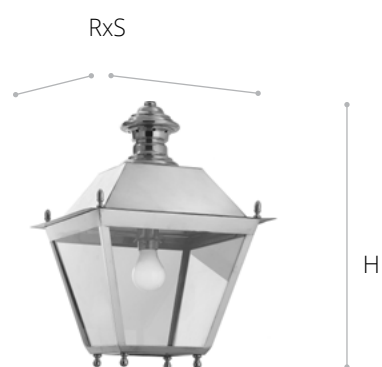
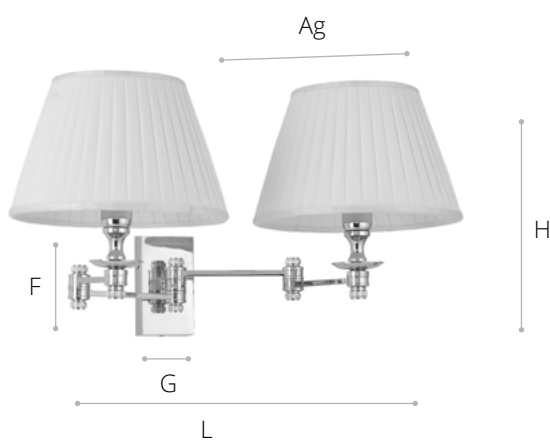
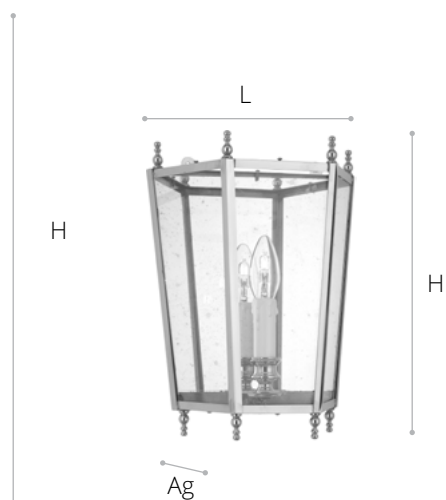



03-APP-015-U

NL Wmax Led WLed K° V

E14 1 40 - - - 220 - 240

dimensioni
dimensions

FxG L H Ag
6x8 | 2²³/₆₄ x 3⁵/₃₂ 20 | 7⁷/₈ 23 | 9¹/₁₆ 26,5 | 10⁷/₁₆

finiture
finishes

on ov ob nl ni ns nsv cl csv al asv nelv nesv olv osv

Applique orientabile.
(Fotografata e misurata con paralume 03-ACC-253-U)
Adjustable wall light
(Photographed and measured with lampshade 03-ACC-253-U)



03-APP-129-U

NL Wmax Led WLed K° V

E14 1 40 - - - 220 - 240

dimensioni
dimensions

FxG L H Ag
6x8 | 2²³/₆₄ x 3⁵/₃₂ 20 | 7⁷/₈ 23,5 | 9¹/₄ 39,5 | 15³⁵/₆₄

finiture
finishes

on ov ob nl ni ns nsv cl csv al asv nelv nesv olv osv

Applique estensibile.
(Fotografata e misurata con paralume 03-ACC-253-U)
Extensible wall light
(Photographed and measured with lampshade 03-ACC-253-U)



03-APP-130-U

NL Wmax Led WLed K° V

E14 2 40 - - - 220 - 240

dimensioni
dimensions

FxG L H Ag
6x10,5 | 2²³/₆₄ x 4⁹/₆₄ 44 | 17²¹/₆₄ 22,5 | 8⁵⁵/₆₄ 36,5 | 14³/₈

finiture
finishes

on ov ob nl ni ns nsv cl csv al asv nelv nesv olv osv

Applique estensibile.
(Fotografata e misurata con paralumi 03-ACC-253-U)
Extensible wall light
(Photographed and measured with lampshade 03-ACC-253-U)



03-APP-061-U

	NL	Wmax	Led	WLed	K°	V
E14	1	40	-	-	-	220 - 240

dimensioni
dimensions

FxG	H	Ag
6x11,3 2 ²³ /64 x 4 ²⁹ /64	42 16 ¹⁷ /32	33 12 ⁶³ /64

finiture
finishes

<input type="radio"/>	<input type="radio"/>	<input type="radio"/>	<input type="radio"/>	<input type="radio"/>	<input type="radio"/>	<input type="radio"/>	<input type="radio"/>	<input type="radio"/>	<input type="radio"/>	<input type="radio"/>	<input type="radio"/>	<input type="radio"/>	<input type="radio"/>	<input type="radio"/>
on	ov	ob	nl	ni	ns	nsv	cl	csv	al	asv	nelv	nesv	olv	osv

Applique con luce di lettura.
Wall lamp with reading light



03-APP-078-U

	NL	Wmax	Led	WLed	K°	V
E14	1	40	-	-	-	220 - 240

dimensioni
dimensions

FxG	L	H	Ag
8,3x11,5 3 ¹⁷ /64 x 4 ¹⁷ /32	15 5 ²⁹ /32	21,5 8 ¹⁵ /32	18 7 ³ /32

finiture
finishes

<input type="radio"/>	<input type="radio"/>	<input type="radio"/>	<input type="radio"/>	<input type="radio"/>	<input type="radio"/>	<input type="radio"/>	<input type="radio"/>	<input type="radio"/>	<input type="radio"/>	<input type="radio"/>	<input type="radio"/>	<input type="radio"/>	<input type="radio"/>	<input type="radio"/>
on	ov	ob	nl	ni	ns	nsv	cl	csv	al	asv	nelv	nesv	olv	osv

Applique.
(Fotografata e misurata con paralume 03-ACC-255-U)
Wall light.
(Photographed and measured with lampshade 03-ACC-255-U)



03-APP-279-U

	NL	Wmax	Led	WLed	K°	V
E14	1	40	-	-	-	220 - 240

dimensioni
dimensions

FxG	L	H	Ag
8x8 3 ⁵ /32 x 3 ⁵ /32	14 5 ³³ /64	31,5 12 ¹⁹ /32	18,5 7 ³¹ /64

finiture
finishes

<input type="radio"/>	<input type="radio"/>	<input type="radio"/>	<input type="radio"/>	<input type="radio"/>	<input type="radio"/>	<input type="radio"/>	<input type="radio"/>	<input type="radio"/>	<input type="radio"/>	<input type="radio"/>	<input type="radio"/>	<input type="radio"/>	<input type="radio"/>	<input type="radio"/>
on	ov	ob	nl	ni	ns	nsv	cl	csv	al	asv	nelv	nesv	olv	osv

Applique.
(Fotografata e misurata con paralume 03-ACC-288-U)
Wall light.
(Photographed and measured with lampshade 03-ACC-288-U)



03-APP-001-U

	NL	Wmax	Led	WLed	K°	V
E14	1	40	-	-	-	220 - 240

dimensioni
dimensions

ØB	L	H	Ag
7 2 ³ / ₄	12,5 4 ⁵⁹ / ₆₄	19 7 ³¹ / ₇₄	17 6 ¹¹ / ₁₆

finiture
finishes

○ on	○ ov	○ ob	○ nl	○ ni	○ ns	○ nsv	○ cl	○ csv	○ al	○ asv	○ nelv	○ nesv	○ olv	○ osv
------	------	------	------	------	------	-------	------	-------	------	-------	--------	--------	-------	-------

Applique.
(Fotografata e misurata con paralume 03-ACC-257-U)
Wall light.
(Photographed and measured with lampshade 03-ACC-257-U)



03-APP-181-U

	NL	Wmax	Led	WLed	K°	V
E14	1	40	-	-	-	220 - 240

dimensioni
dimensions

ØB	L	H	Ag
10,5 4 ⁹ / ₆₄	20 7 ⁷ / ₈	27 10 ⁵ / ₈	36,5 14 ³ / ₈

finiture
finishes

○ on	○ ov	○ ob	○ nl	○ ni	○ ns	○ nsv	○ cl	○ csv	○ al	○ asv	○ nelv	○ nesv	○ olv	○ osv
------	------	------	------	------	------	-------	------	-------	------	-------	--------	--------	-------	-------

Applique estensibile.
(Fotografata e misurata con paralume 03-ACC-253-U)
Extensible wall light.
(Photographed and measured with lampshade 03-ACC-253-U)



03-APP-209-U

	NL	Wmax	Led	WLed	K°	V
E14	1	40	-	-	-	220 - 240

dimensioni
dimensions

ØB	L	H	Ag
10,5 4 ⁹ / ₆₄	20 7 ⁷ / ₈	27 10 ⁵ / ₈	30,5 12 ¹ / ₆₄

finiture
finishes

○ on	○ ov	○ ob	○ nl	○ ni	○ ns	○ nsv	○ cl	○ csv	○ al	○ asv	○ nelv	○ nesv	○ olv	○ osv
------	------	------	------	------	------	-------	------	-------	------	-------	--------	--------	-------	-------

Applique orientabile.
(Fotografata e misurata con paralume 03-ACC-253-U)
Extensible wall light.
(Photographed and measured with lampshade 03-ACC-253-U)



03-APP-210-U

dimensioni
dimensions

finiture
finishes

	NL	Wmax	Led	WLed	K°	V
E14	2	40	-	-	-	220 - 240
ØB	L		H		Ag	
10,5 4 ⁹ /64	37 14 ⁹ /16		32 12 ¹⁹ /32		24 9 ²⁹ /64	
○	○	○	○	○	○	○
on	ov	ob	nl	ni	ns	nsv
○	○	○	○	○	○	○
cl	csv	al	asv	nelv	nesv	olv
○	○	○	○	○	○	○
osv						

Applique orientabile.
(Fotografata e misurata con paralumi 03-ACC-256-U)
Adjustable wall light.
(Photographed and measured with lampshade 03-ACC-256-U)



03-APP-106-U

dimensioni
dimensions

finiture
finishes

	NL	Wmax	Led	WLed	K°	V
E14	1	40	-	-	-	220 - 240
ØB	L		H		Ag	
9,5 3 ⁴⁷ /64	23 9 ¹ /16		32,5 12 ⁵¹ /64		43 16 ⁵⁹ /64	
○	○	○	○	○	○	○
on	ov	ob	nl	ni	ns	nsv
○	○	○	○	○	○	○
cl	csv	al	asv	nelv	nesv	olv
○	○	○	○	○	○	○
osv						

Applique orientabile.
(Fotografata e misurata con paralume 03-ACC-254-U)
Adjustable wall light.
(Photographed and measured with lampshade 03-ACC-254-U)



03-APP-188-U

dimensioni
dimensions

finiture
finishes

	NL	Wmax	Led	WLed	K°	V
E14	1	40	-	-	-	220 - 240
FxG	L		H		Ag	
7x10,5 2 ³ /4 x 4 ⁹ /64	12,5 4 ⁵⁹ /64		20,5 8 ⁵ /64		21,5 8 ¹⁵ /32	
○	○	○	○	○	○	○
on	ov	ob	nl	ni	ns	nsv
○	○	○	○	○	○	○
cl	csv	al	asv	nelv	nesv	olv
○	○	○	○	○	○	○
osv						

Applique.
(Fotografata e misurata con paralume 03-ACC-257-U)
Wall light.
(Photographed and measured with lampshade 03-ACC-257-U)



03-APP-031-U

dimensioni
dimensions

finiture
finishes

	NL	Wmax	Led	WLed	K°	V
E14	1	40	-	-	-	220 - 240
FxG	L		H		Ag	
6x10 2 ²³ / ₆₄ x 3 ¹⁵ / ₁₆	20 7 ⁷ / ₈		28,5 11 ⁷ / ₃₂		28,5 11 ⁷ / ₃₂	
	<input type="radio"/>	<input type="radio"/>	<input type="radio"/>	<input type="radio"/>	<input type="radio"/>	<input type="radio"/>
	on	ov	ob	nl	ni	ns
	<input type="radio"/>	<input type="radio"/>	<input type="radio"/>	<input type="radio"/>	<input type="radio"/>	<input type="radio"/>
	nsv	cl	csv	al	asv	nelv
	<input type="radio"/>	<input type="radio"/>	<input type="radio"/>	<input type="radio"/>	<input type="radio"/>	<input type="radio"/>
	nesv	olv	osv			

Applique orientabile.
(Fotografata e misurata con paralume 03-ACC-253-U)
Adjustable wall light.
(Photographed and measured with lampshade 03-ACC-253-U)



03-APP-103-U

dimensioni
dimensions

finiture
finishes

	NL	Wmax	Led	WLed	K°	V
E14	1	40	-	-	-	220 - 240
ØB	L		H		Ag	
8,5 3 ¹¹ / ₃₂	23 9 ¹ / ₁₆		49,5 19 ³¹ / ₆₄		56 22 ³ / ₆₄	
	<input type="radio"/>	<input type="radio"/>	<input type="radio"/>	<input type="radio"/>	<input type="radio"/>	<input type="radio"/>
	on	ov	ob	nl	ni	ns
	<input type="radio"/>	<input type="radio"/>	<input type="radio"/>	<input type="radio"/>	<input type="radio"/>	<input type="radio"/>
	nsv	cl	csv	al	asv	nelv
	<input type="radio"/>	<input type="radio"/>	<input type="radio"/>	<input type="radio"/>	<input type="radio"/>	<input type="radio"/>
	nesv	olv	osv			

Applique estensibile.
(Fotografata e misurata con paralume 03-ACC-254-U)
Extensible wall light.
(Photographed and measured with lampshade 03-ACC-254-U)



03-APP-070-U

dimensioni
dimensions

finiture
finishes

	NL	Wmax	Led	WLed	K°	V
E14	1	40	-	-	-	220 - 240
FxG	L		H		Ag	
4,5x24 1 ⁴⁹ / ₆₄ x 9 ²⁹ / ₆₄	23 9 ¹ / ₁₆		43 16 ⁵⁹ / ₆₄		40 15 ³ / ₄	
	<input type="radio"/>	<input type="radio"/>	<input type="radio"/>	<input type="radio"/>	<input type="radio"/>	<input type="radio"/>
	on	ov	ob	nl	ni	ns
	<input type="radio"/>	<input type="radio"/>	<input type="radio"/>	<input type="radio"/>	<input type="radio"/>	<input type="radio"/>
	nsv	cl	csv	al	asv	nelv
	<input type="radio"/>	<input type="radio"/>	<input type="radio"/>	<input type="radio"/>	<input type="radio"/>	<input type="radio"/>
	nesv	olv	osv			

Applique estensibile.
(Fotografata e misurata con paralume 03-ACC-254-U)
Extensible wall light.
(Photographed and measured with lampshade 03-ACC-254-U)



03-APP-018-U

	NL	Wmax	Led	WLed	K°	V
E14	1	40	-	-	-	220 - 240

dimensioni
dimensions

ØB	L	H	Ag
14,5 5 ⁴⁵ /64	21 8 ¹⁷ /64	30 11 ¹³ /16	24 9 ²⁹ /64

finiture
finishes

○ ○ ○ ○ ○ ○ ○ ○ ○ ○ ○ ○ ○ ○ ○
on ov ob nl ni ns nsv cl csv al asv nelv nesv olv osv

Applique con ventola in lamiera.
Wall light with sheet metal shade.



03-APP-246-U

	NL	Wmax	Led	WLed	K°	V
E14	1	40	-	-	-	220 - 240

dimensioni
dimensions

ØB	L	H	Ag
14,5 5 ⁴⁵ /64	21 8 ¹⁷ /64	31,5 12 ¹³ /32	24 9 ²⁹ /64

finiture
finishes

○ ○ ○ ○ ○ ○ ○ ○ ○ ○ ○ ○ ○ ○ ○
on ov ob nl ni ns nsv cl csv al asv nelv nesv olv osv

Applique con paralume in pergamena.
Wall light with parchment lampshade.



03-APP-135-U

	NL	Wmax	Led	WLed	K°	V
E27	1	60	-	-	-	220 - 240

dimensioni
dimensions

ØB	L	H	Ag
9 3 ³⁵ /64	23,5 9 ¹ /4	31,5 12 ¹³ /32	31 12 ¹³ /64

finiture
finishes

○ ○ ○ ○ ○ ○ ○ ○ ○ ○ ○ ○ ○ ○ ○
on ov ob nl ni ns nsv cl csv al asv nelv nesv olv osv

Applique.
(Fotografata e misurata con paralume 03-ACC-259-U)
Wall light.
(Photographed and measured with lampshade 03-ACC-259-U)



03-APP-084-U

NL Wmax Led WLed K° V

E14 1 40 - - - 220 - 240

dimensioni
dimensions

ØB L H Ag
10 | 3¹⁵/₁₆ 20 | 7⁷/₈ 33 | 12⁶³/₆₄ 42 | 16¹⁷/₃₂

finiture
finishes

on ov ob nl ni ns nsv cl csv al asv nelv nesv olv osv

Applique con base in legno.
(Fotografata e misurata con paralume 03-ACC-253-U)
Wall light with wooden base.
(Photographed and measured with lampshade 03-ACC-253-U)



03-APP-048-U

NL Wmax Led WLed K° V

E14 2 40 - - - 220 - 240

dimensioni
dimensions

ØB L H Ag
9,5 | 3⁴⁷/₆₄ 37 | 14⁹/₁₆ 38,5 | 15⁵/₃₂ 19,5 | 7⁴³/₆₄

finiture
finishes

on ov ob nl ni ns nsv cl csv al asv nelv nesv olv osv

Applique.
(Fotografata e misurata con paralumi 03-ACC-255-U)
Wall light.
(Photographed and measured with lampshade 03-ACC-255-U)



03-APP-029-U

NL Wmax Led WLed K° V

E27 1 60 - - - 220 - 240

dimensioni
dimensions

FxG L H Ag
5,5x15,5 | 2¹¹/₆₄ x 6⁷/₆₄ 25 | 9²⁷/₃₂ 46 | 18⁷/₆₄ 81 | 31⁵⁷/₆₄

finiture
finishes

on ov ob nl ni ns nsv cl csv al asv nelv nesv olv osv

Applique estensibile con ventola in lamiera.
Extensible wall light with sheet metal shade.



03-APP-213-U

	NL	Wmax	Led	WLed	K°	V
E27	1	40	-	-	-	220 - 240

dimensioni
dimensions

ØB	L	H	Ag
10,5 4 ⁹ /64	14 5 ³³ /64	24 9 ²⁴ /64	27,5 10 ⁵³ /64

finiture
finishes

<input type="radio"/>	<input type="radio"/>	<input type="radio"/>	<input type="radio"/>	<input type="radio"/>	<input type="radio"/>	<input type="radio"/>	<input type="radio"/>	<input type="radio"/>	<input type="radio"/>	<input type="radio"/>	<input type="radio"/>	<input type="radio"/>	<input type="radio"/>	<input type="radio"/>
on	ov	ob	nl	ni	ns	nsv	cl	csv	al	asv	nelv	nesv	olv	osv

Applique con vetro opaline.
Wall light with opaline glass.



03-APP-214-U

	NL	Wmax	Led	WLed	K°	V
E27	1	40	-	-	-	220 - 240

dimensioni
dimensions

ØB	L	H	Ag
10,5 4 ⁹ /64	14 5 ³³ /64	24 9 ²⁴ /64	27,5 10 ⁵³ /64

finiture
finishes

<input type="radio"/>	<input type="radio"/>	<input type="radio"/>	<input type="radio"/>	<input type="radio"/>	<input type="radio"/>	<input type="radio"/>	<input type="radio"/>	<input type="radio"/>	<input type="radio"/>	<input type="radio"/>	<input type="radio"/>	<input type="radio"/>	<input type="radio"/>	<input type="radio"/>
on	ov	ob	nl	ni	ns	nsv	cl	csv	al	asv	nelv	nesv	olv	osv

Applique orientabile con vetro sabbiato e molato.
Adjustable wall light with sandblasted/beveled glass.



03-APP-047-U

	NL	Wmax	Led	WLed	K°	V
E14	1	40	-	-	-	220 - 240

dimensioni
dimensions

FxG	L	H	Ag
6,8x10,8 2 ⁴³ /64 x 4 ¹ /4	10 3 ¹⁵ /16	20,5 8 ⁵ /64	21 8 ¹⁷ /64

finiture
finishes

<input type="radio"/>	<input type="radio"/>	<input type="radio"/>	<input type="radio"/>	<input type="radio"/>	<input type="radio"/>	<input type="radio"/>	<input type="radio"/>	<input type="radio"/>	<input type="radio"/>	<input type="radio"/>	<input type="radio"/>	<input type="radio"/>	<input type="radio"/>	<input type="radio"/>
on	ov	ob	nl	ni	ns	nsv	cl	csv	al	asv	nelv	nesv	olv	osv

Applique con vetro opaline.
Wall light with opaline glass.



03-APP-182-U

	NL	Wmax	Led	WLed	K°	V
E27	1	40	-	-	-	220 - 240

dimensioni
dimensions

FxG	L	H	Ag
11,7x11,7 4 ³⁹ /64 x 4 ³⁹ /64	16 6 ¹⁹ /64	30 11 ¹³ /16	31 12 ¹³ /64

finiture
finishes

<input type="radio"/>	<input type="radio"/>	<input type="radio"/>	<input type="radio"/>	<input type="radio"/>	<input type="radio"/>	<input type="radio"/>	<input type="radio"/>	<input type="radio"/>	<input type="radio"/>	<input type="radio"/>	<input type="radio"/>	<input type="radio"/>	<input type="radio"/>	<input type="radio"/>
on	ov	ob	nl	ni	ns	nsv	cl	csv	al	asv	nelv	nesv	olv	osv

Applique con vetro opaline.
Wall light with opaline glass.



03-APP-183-U

	NL	Wmax	Led	WLed	K°	V
E27	1	40	-	-	-	220 - 240

dimensioni
dimensions

FxG	L	H	Ag
11,7x11,7 4 ³⁹ /64 x 4 ³⁹ /64	14 5 ³³ /64	28 11 ¹ /32	30 11 ¹³ /16

finiture
finishes

<input type="radio"/>	<input type="radio"/>	<input type="radio"/>	<input type="radio"/>	<input type="radio"/>	<input type="radio"/>	<input type="radio"/>	<input type="radio"/>	<input type="radio"/>	<input type="radio"/>	<input type="radio"/>	<input type="radio"/>	<input type="radio"/>	<input type="radio"/>	<input type="radio"/>
on	ov	ob	nl	ni	ns	nsv	cl	csv	al	asv	nelv	nesv	olv	osv

Applique con vetro sabbato e molato.
Wall light with sandblasted/beveled glass.



03-APP-189-U

	NL	Wmax	Led	WLed	K°	V
E27	1	40	-	-	-	220 - 240

dimensioni
dimensions

ØB	L	H	Ag
12 4 ²³ /32	14 5 ³³ /64	23,5 9 ¹ /4	23,5 9 ¹ /4

finiture
finishes

<input type="radio"/>	<input type="radio"/>	<input type="radio"/>	<input type="radio"/>	<input type="radio"/>	<input type="radio"/>	<input type="radio"/>	<input type="radio"/>	<input type="radio"/>	<input type="radio"/>	<input type="radio"/>	<input type="radio"/>	<input type="radio"/>	<input type="radio"/>	<input type="radio"/>
on	ov	ob	nl	ni	ns	nsv	cl	csv	al	asv	nelv	nesv	olv	osv

Applique con vetro opaline.
Wall light with opaline glass.



03-APP-190-U

Icona	NL	Wmax	Led	WLed	K°	V
-------	----	------	-----	------	----	---

E27	1	40	-	-	-	220 - 240
-----	---	----	---	---	---	-----------

dimensioni
dimensions

ØB	L	H	Ag
12 4 ²³ /32	14 5 ³³ /64	23,5 9 ¹ /4	23,5 9 ¹ /4

finiture
finishes

<input type="radio"/>	<input type="radio"/>	<input type="radio"/>	<input type="radio"/>	<input type="radio"/>	<input type="radio"/>	<input type="radio"/>	<input type="radio"/>	<input type="radio"/>	<input type="radio"/>	<input type="radio"/>	<input type="radio"/>	<input type="radio"/>	<input type="radio"/>	<input type="radio"/>
on	ov	ob	nl	ni	ns	nsv	cl	csv	al	asv	nelv	nesv	olv	osv

Applique con vetro sabbato e molato.
Wall light with sandblasted/beveled glass.



03-APP-207-U

Icona	NL	Wmax	Led	WLed	K°	V
-------	----	------	-----	------	----	---

E27	1	40	-	-	-	220 - 240
-----	---	----	---	---	---	-----------

dimensioni
dimensions

ØB	L	H	Ag
12 4 ²³ /32	14 5 ³³ /64	24 9 ²⁴ /64	37 14 ⁹ /16

finiture
finishes

<input type="radio"/>	<input type="radio"/>	<input type="radio"/>	<input type="radio"/>	<input type="radio"/>	<input type="radio"/>	<input type="radio"/>	<input type="radio"/>	<input type="radio"/>	<input type="radio"/>	<input type="radio"/>	<input type="radio"/>	<input type="radio"/>	<input type="radio"/>	<input type="radio"/>
on	ov	ob	nl	ni	ns	nsv	cl	csv	al	asv	nelv	nesv	olv	osv

Applique con vetro opaline.
Wall light with opaline glass.



03-APP-208-U

Icona	NL	Wmax	Led	WLed	K°	V
-------	----	------	-----	------	----	---

E27	1	40	-	-	-	220 - 240
-----	---	----	---	---	---	-----------

dimensioni
dimensions

ØB	L	H	Ag
12 4 ²³ /32	14 5 ³³ /64	24 9 ²⁴ /64	37 14 ⁹ /16

finiture
finishes

<input type="radio"/>	<input type="radio"/>	<input type="radio"/>	<input type="radio"/>	<input type="radio"/>	<input type="radio"/>	<input type="radio"/>	<input type="radio"/>	<input type="radio"/>	<input type="radio"/>	<input type="radio"/>	<input type="radio"/>	<input type="radio"/>	<input type="radio"/>	<input type="radio"/>
on	ov	ob	nl	ni	ns	nsv	cl	csv	al	asv	nelv	nesv	olv	osv

Applique con vetro sabbato e molato.
Wall light with sandblasted/beveled glass.



03-APP-071-U

	NL	Wmax	Led	WLed	K°	V
E27	1	40	-	-	-	220 - 240

dimensioni
dimensions

ØB	L	H	Ag
12 4 ²³ /32	14 5 ³³ /64	28 11 ¹ /32	36 14 ¹¹ /64

finiture
finishes

<input type="radio"/>	<input type="radio"/>	<input type="radio"/>	<input type="radio"/>	<input type="radio"/>	<input type="radio"/>	<input type="radio"/>	<input type="radio"/>	<input type="radio"/>	<input type="radio"/>	<input type="radio"/>	<input type="radio"/>	<input type="radio"/>	<input type="radio"/>	<input type="radio"/>
on	ov	ob	nl	ni	ns	nsv	cl	csv	al	asv	nelv	nesv	olv	osv

Applique con vetro opaline.
Wall light with opaline glass.



03-APP-072-U

	NL	Wmax	Led	WLed	K°	V
E27	1	40	-	-	-	220 - 240

dimensioni
dimensions

ØB	L	H	Ag
12 4 ²³ /32	14 5 ³³ /64	28 11 ¹ /34	36 14 ¹¹ /64

finiture
finishes

<input type="radio"/>	<input type="radio"/>	<input type="radio"/>	<input type="radio"/>	<input type="radio"/>	<input type="radio"/>	<input type="radio"/>	<input type="radio"/>	<input type="radio"/>	<input type="radio"/>	<input type="radio"/>	<input type="radio"/>	<input type="radio"/>	<input type="radio"/>	<input type="radio"/>
on	ov	ob	nl	ni	ns	nsv	cl	csv	al	asv	nelv	nesv	olv	osv

Applique con vetro sabbato e molato.
Wall light with sandblasted/beveled glass.



03-APP-032-U

	NL	Wmax	Led	WLed	K°	V
E27	1	40	-	-	-	220 - 240

dimensioni
dimensions

ØB	L	H	Ag
9 3 ³⁵ /64	14 5 ³³ /64	39,5 15 ³⁵ /64	31,5 12 ¹³ /32

finiture
finishes

<input type="radio"/>	<input type="radio"/>	<input type="radio"/>	<input type="radio"/>	<input type="radio"/>	<input type="radio"/>	<input type="radio"/>	<input type="radio"/>	<input type="radio"/>	<input type="radio"/>	<input type="radio"/>	<input type="radio"/>	<input type="radio"/>	<input type="radio"/>	<input type="radio"/>
on	ov	ob	nl	ni	ns	nsv	cl	csv	al	asv	nelv	nesv	olv	osv

Applique con vetro sabbato e molato.
Wall light with sandblasted/beveled glass.



03-APP-104-U

dimensioni
dimensions

finiture
finishes

	NL	Wmax	Led	WLed	K°	V
E14	1	40	-	-	-	220 - 240
FxG	L		H		Ag	
9x29,5 3 ³⁵ /64 x 11 ³⁹ /64	14 5 ³³ /64		29,5 11 ³⁹ /64		26 10 ¹⁵ /64	
	<input type="radio"/>	<input type="radio"/>	<input type="radio"/>	<input type="radio"/>	<input type="radio"/>	<input type="radio"/>
	on	ov	ob	nl	ni	ns
	<input type="radio"/>	<input type="radio"/>	<input type="radio"/>	<input type="radio"/>	<input type="radio"/>	<input type="radio"/>
	nsv	cl	csv	al	asv	nelv
	<input type="radio"/>	<input type="radio"/>	<input type="radio"/>	<input type="radio"/>	<input type="radio"/>	<input type="radio"/>
	nesv	olv	osv			

Applique con vetro sabbato e molato.
Wall light with sandblasted/beveled glass.



03-APP-105-U

dimensioni
dimensions

finiture
finishes

	NL	Wmax	Led	WLed	K°	V
E14	2	40	-	-	-	220 - 240
FxG	L		H		Ag	
9x29,5 3 ³⁵ /64 x 11 ³⁹ /64	39 15 ²³ /64		33 12 ⁶³ /64		31 12 ¹³ /64	
	<input type="radio"/>	<input type="radio"/>	<input type="radio"/>	<input type="radio"/>	<input type="radio"/>	<input type="radio"/>
	on	ov	ob	nl	ni	ns
	<input type="radio"/>	<input type="radio"/>	<input type="radio"/>	<input type="radio"/>	<input type="radio"/>	<input type="radio"/>
	nsv	cl	csv	al	asv	nelv
	<input type="radio"/>	<input type="radio"/>	<input type="radio"/>	<input type="radio"/>	<input type="radio"/>	<input type="radio"/>
	nesv	olv	osv			

Applique con vetri sabbati e molati.
Wall light with sandblasted/beveled glass elements.



03-APP-002-U

dimensioni
dimensions

finiture
finishes

	NL	Wmax	Led	WLed	K°	V
E14	1	40	-	-	-	220 - 240
ØB	L		H		Ag	
7 2 ³ /4	12,5 4 ⁵⁹ /64		19 7 ³¹ /64		17 6 ¹¹ /16	
	<input type="radio"/>	<input type="radio"/>	<input type="radio"/>	<input type="radio"/>	<input type="radio"/>	<input type="radio"/>
	on	ov	ob	nl	ni	ns
	<input type="radio"/>	<input type="radio"/>	<input type="radio"/>	<input type="radio"/>	<input type="radio"/>	<input type="radio"/>
	nsv	cl	csv	al	asv	nelv
	<input type="radio"/>	<input type="radio"/>	<input type="radio"/>	<input type="radio"/>	<input type="radio"/>	<input type="radio"/>
	nesv	olv	osv			

Applique.
(Fotografata e misurata con paralume 03-ACC-258-U).
Wall light.
(Photographed and measured with lampshade 03-ACC-258-U)



03-APP-191-U

Icona	NL	Wmax	Led	WLed	K°	V
B22	1	25	-	-	-	220 - 240

dimensioni
dimensions

ØB	L	H	Ag
6,8 2 ⁴³ /64	12,5 4 ⁵⁹ /64	16,5 6 ¹ /2	30 11 ¹³ /16

finiture
finishes

<input type="radio"/>	<input type="radio"/>	<input type="radio"/>	<input type="radio"/>	<input type="radio"/>	<input type="radio"/>	<input type="radio"/>	<input type="radio"/>	<input type="radio"/>	<input type="radio"/>	<input type="radio"/>	<input type="radio"/>	<input type="radio"/>	<input type="radio"/>	<input type="radio"/>
on	ov	ob	nl	ni	ns	nsv	cl	csv	al	asv	nelv	nesv	olv	osv

Applique.
(Fotografata e misurata con paralume 03-ACC-258-U)
Wall light.
(Photographed and measured with lampshade 03-ACC-258-U)



03-APP-275-U

Icona	NL	Wmax	Led	WLed	K°	V
E27	1	25	-	-	-	220 - 240

dimensioni
dimensions

ØB	L	H	Ag
12 4 ²³ /32	19 7 ³¹ /64	17 6 ¹¹ /16	28 11 ¹ /32

finiture
finishes

<input type="radio"/>	<input type="radio"/>	<input type="radio"/>	<input type="radio"/>	<input type="radio"/>	<input type="radio"/>	<input type="radio"/>	<input type="radio"/>	<input type="radio"/>	<input type="radio"/>	<input type="radio"/>	<input type="radio"/>	<input type="radio"/>	<input type="radio"/>	<input type="radio"/>
on	ov	ob	nl	ni	ns	nsv	cl	csv	al	asv	nelv	nesv	olv	osv

Applique.
(Fotografata e misurata con paralume 03-ACC-285-U)
Wall light.
(Photographed and measured with lampshade 03-ACC-285-U)



03-APP-007-U

Icona	NL	Wmax	Led	WLed	K°	V
E14	1	25	-	-	-	220 - 240

dimensioni
dimensions

ØB	L	H	Ag
7 2 ³ /4	20,5 8 ⁵ /64	13,5 5 ⁵ /16	29 11 ²⁷ /64

finiture
finishes

<input type="radio"/>	<input type="radio"/>	<input type="radio"/>	<input type="radio"/>	<input type="radio"/>	<input type="radio"/>	<input type="radio"/>	<input type="radio"/>	<input type="radio"/>	<input type="radio"/>	<input type="radio"/>	<input type="radio"/>	<input type="radio"/>	<input type="radio"/>	<input type="radio"/>
on	ov	ob	nl	ni	ns	nsv	cl	csv	al	asv	nelv	nesv	olv	osv

Applique con borchia in metallo e ventola in lamiera.
Wall light with metal cover body and sheet metal shade.



03-APP-008-U

	NL	Wmax	Led	WLed	K°	V
E14	1	25	-	-	-	220 - 240

dimensioni
dimensions

ØB	L	H	Ag
7 2 ³ / ₄	12,5 4 ⁵⁹ / ₆₄	17,5 6 ⁵⁷ / ₆₄	25 9 ²⁷ / ₃₂

finiture
finishes

<input type="radio"/>	<input type="radio"/>	<input type="radio"/>	<input type="radio"/>	<input type="radio"/>	<input type="radio"/>	<input type="radio"/>	<input type="radio"/>	<input type="radio"/>	<input type="radio"/>	<input type="radio"/>	<input type="radio"/>	<input type="radio"/>	<input type="radio"/>	<input type="radio"/>
on	ov	ob	nl	ni	ns	nsv	cl	csv	al	asv	nelv	nesv	olv	osv

Applique con borchia in metallo e vetro sabbato e molato.
Wall light with metal cover body and sandblasted/beveled glass.



03-APP-009-U

	NL	Wmax	Led	WLed	K°	V
E14	1	25	-	-	-	220 - 240

dimensioni
dimensions

ØB	L	H	Ag
7 2 ³ / ₄	17,5 6 ⁵⁷ / ₆₄	14 5 ³³ / ₆₄	28 11 ¹ / ₃₂

finiture
finishes

<input type="radio"/>	<input type="radio"/>	<input type="radio"/>	<input type="radio"/>	<input type="radio"/>	<input type="radio"/>	<input type="radio"/>	<input type="radio"/>	<input type="radio"/>	<input type="radio"/>	<input type="radio"/>	<input type="radio"/>	<input type="radio"/>	<input type="radio"/>	<input type="radio"/>
on	ov	ob	nl	ni	ns	nsv	cl	csv	al	asv	nelv	nesv	olv	osv

Applique con borchia in metallo e vetro opaline.
Wall light with metal cover body and opaline glass.



03-APP-010-U

	NL	Wmax	Led	WLed	K°	V
E14	1	25	-	-	-	220 - 240

dimensioni
dimensions

ØB	L	H	Ag
7 2 ³ / ₄	20,5 8 ⁵ / ₆₄	13,5 5 ⁵ / ₁₆	29 11 ²⁷ / ₆₄

finiture
finishes

<input type="radio"/>	<input type="radio"/>	<input type="radio"/>	<input type="radio"/>	<input type="radio"/>	<input type="radio"/>	<input type="radio"/>	<input type="radio"/>	<input type="radio"/>	<input type="radio"/>	<input type="radio"/>	<input type="radio"/>	<input type="radio"/>	<input type="radio"/>	<input type="radio"/>
on	ov	ob	nl	ni	ns	nsv	cl	csv	al	asv	nelv	nesv	olv	osv

Applique con borchia in porcellana e ventola in lamiera.
Wall light with porcelain cover body and sheet metal shade.



03-APP-011-U

dimensioni
dimensions

finiture
finishes

	NL	Wmax	Led	WLed	K°	V
E14	1	25	-	-	-	220 - 240
ØB		L	H	Ag		
7 2 ³ / ₄		12,5 4 ⁵⁹ / ₆₄	17,5 6 ⁵⁷ / ₆₄	25 9 ²⁷ / ₃₂		
○ ○ ○ ○ ○ ○ ○ ○ ○ ○ ○ ○ ○ ○ ○						
on ov ob nl ni ns nsv cl csv al asv nelv nesv olv osv						

Applique con borchia in porcellana e vetro sabbato e molato.
Wall light with porcelain cover body and sandblasted/beveled glass.



03-APP-012-U

dimensioni
dimensions

finiture
finishes

	NL	Wmax	Led	WLed	K°	V
E14	1	25	-	-	-	220 - 240
ØB		L	H	Ag		
7 2 ³ / ₄		17,5 6 ⁵⁷ / ₆₄	14 5 ³³ / ₆₄	28 11 ¹ / ₃₂		
○ ○ ○ ○ ○ ○ ○ ○ ○ ○ ○ ○ ○ ○ ○						
on ov ob nl ni ns nsv cl csv al asv nelv nesv olv osv						

Applique con borchia in porcellana e vetro opaline.
Wall light with porcelain cover body and opaline glass.



03-APP-013-U

dimensioni
dimensions

finiture
finishes

	NL	Wmax	Led	WLed	K°	V
E14	2	25	-	-	-	220 - 240
ØB		L	H	Ag		
7 2 ³ / ₄		32 12 ¹⁹ / ₃₂	17,5 6 ⁵⁷ / ₆₄	23,5 9 ¹ / ₄		
○ ○ ○ ○ ○ ○ ○ ○ ○ ○ ○ ○ ○ ○ ○						
on ov ob nl ni ns nsv cl csv al asv nelv nesv olv osv						

Applique con borchia in metallo e vetro sabbato e molato.
Wall light with metal cover body and sandblasted/beveled glass.



03-APP-014-U

dimensioni
dimensions

finiture
finishes

	NL	Wmax	Led	WLed	K°	V
E14	2	25	-	-	-	220 - 240
ØB	L		H		Ag	
7 2 ³ / ₄	32 12 ¹⁹ / ₃₂		17,5 6 ⁵⁷ / ₆₄		23,5 9 ¹ / ₄	
○	○	○	○	○	○	○
on	ov	ob	nl	ni	ns	nsv
○	○	○	○	○	○	○
cl	csv	al	asv	nelv	nesv	olv
○	○	○	○	○	○	○
osv						

Applique con borchia in porcellana e vetro sabbato e molato.
Wall light with porcelain cover body and sandblasted/beveled glass.



03-APP-184-U

dimensioni
dimensions

finiture
finishes

	NL	Wmax	Led	WLed	K°	V
E14	2	25	-	-	-	220 - 240
ØB	L		H		Ag	
9,5 3 ⁴⁷ / ₆₄	40 15 ³ / ₄		28 11 ¹ / ₃₂		21 8 ¹⁷ / ₆₄	
○	○	○	○	○	○	○
on	ov	ob	nl	ni	ns	nsv
○	○	○	○	○	○	○
cl	csv	al	asv	nelv	nesv	olv
○	○	○	○	○	○	○
osv						

Applique con vetri opaline.
Wall light with opaline glass elements.



03-APP-185-U

dimensioni
dimensions

finiture
finishes

	NL	Wmax	Led	WLed	K°	V
E14	2	25	-	-	-	220 - 240
ØB	L		H		Ag	
9,5 3 ⁴⁷ / ₆₄	35 13 ²⁵ / ₃₂		32 12 ¹⁹ / ₃₂		19 7 ³¹ / ₆₄	
○	○	○	○	○	○	○
on	ov	ob	nl	ni	ns	nsv
○	○	○	○	○	○	○
cl	csv	al	asv	nelv	nesv	olv
○	○	○	○	○	○	○
osv						

Applique con vetri molati e sabbati.
Wall light with sandblasted/beveled glass elements.



03-APP-134-U

	NL	Wmax	Led	WLed	K°	V
E14	1	40	-	-	-	220 - 240

dimensioni
dimensions

ØB	L	H	Ag
9,5 3 ⁴⁷ /64	20,5 8 ⁵ /64	14,5 5 ⁴⁵ /64	40 15 ³ /4

finiture
finishes

○	○	○	○	○	○	○	○	○	○	○	○	○	○	○
on	ov	ob	nl	ni	ns	nsv	cl	csv	al	asv	nelv	nesv	olv	osv

Applique orientabile con ventola in lamiera.
Adjustable wall light with sheet metal shade.



03-APP-132-U

	NL	Wmax	Led	WLed	K°	V
E14	1	40	-	-	-	220 - 240

dimensioni
dimensions

ØB	L	H	Ag
9,5 3 ⁴⁷ /64	12,5 4 ⁵⁹ /64	18 7 ³ /32	35,5 13 ³¹ /32

finiture
finishes

○	○	○	○	○	○	○	○	○	○	○	○	○	○	○
on	ov	ob	nl	ni	ns	nsv	cl	csv	al	asv	nelv	nesv	olv	osv

Applique orientabile con vetro sabbato e molato.
Adjustable wall light with sandblasted/beveled glass.



03-APP-133-U

	NL	Wmax	Led	WLed	K°	V
E14	1	40	-	-	-	220 - 240

dimensioni
dimensions

ØB	L	H	Ag
9,5 3 ⁴⁷ /64	17,5 6 ⁵⁷ /64	14 5 ³³ /64	38,5 15 ⁵ /32

finiture
finishes

○	○	○	○	○	○	○	○	○	○	○	○	○	○	○
on	ov	ob	nl	ni	ns	nsv	cl	csv	al	asv	nelv	nesv	olv	osv

Applique orientabile con vetro opaline.
Adjustable wall light with opaline glass.



03-APP-248-U

	NL	Wmax	Led	WLed	K°	V
E14	2	40	-	-	-	220 - 240

dimensioni
dimensions

ØB	L	H	Ag
9,5 3 ⁴⁷ /64	44 17 ²¹ /64	14 5 ³³ /64	36,5 14 ³ /8

finiture
finishes

<input type="radio"/>	<input type="radio"/>	<input type="radio"/>	<input type="radio"/>	<input type="radio"/>	<input type="radio"/>	<input type="radio"/>	<input type="radio"/>	<input type="radio"/>	<input type="radio"/>	<input type="radio"/>	<input type="radio"/>	<input type="radio"/>	<input type="radio"/>	<input type="radio"/>
on	ov	ob	nl	ni	ns	nsv	cl	csv	al	asv	nelv	nesv	olv	osv

Applique con ventole in lamiera.
Wall light with sheet metal shades.



03-APP-206-U

	NL	Wmax	Led	WLed	K°	V
E14	2	40	-	-	-	220 - 240

dimensioni
dimensions

ØB	L	H	Ag
9,5 3 ⁴⁷ /64	36 14 ¹¹ /64	19 7 ³¹ /64	33 12 ⁶³ /64

finiture
finishes

<input type="radio"/>	<input type="radio"/>	<input type="radio"/>	<input type="radio"/>	<input type="radio"/>	<input type="radio"/>	<input type="radio"/>	<input type="radio"/>	<input type="radio"/>	<input type="radio"/>	<input type="radio"/>	<input type="radio"/>	<input type="radio"/>	<input type="radio"/>	<input type="radio"/>
on	ov	ob	nl	ni	ns	nsv	cl	csv	al	asv	nelv	nesv	olv	osv

Applique con vetri molati e sabbati.
Wall light with sandblasted/beveled glass elements.



03-APP-205-U

	NL	Wmax	Led	WLed	K°	V
E14	2	40	-	-	-	220 - 240

dimensioni
dimensions

ØB	L	H	Ag
9,5 3 ⁴⁷ /64	41,5 16 ¹¹ /32	14,5 5 ⁴⁵ /64	35 13 ²⁵ /32

finiture
finishes

<input type="radio"/>	<input type="radio"/>	<input type="radio"/>	<input type="radio"/>	<input type="radio"/>	<input type="radio"/>	<input type="radio"/>	<input type="radio"/>	<input type="radio"/>	<input type="radio"/>	<input type="radio"/>	<input type="radio"/>	<input type="radio"/>	<input type="radio"/>	<input type="radio"/>
on	ov	ob	nl	ni	ns	nsv	cl	csv	al	asv	nelv	nesv	olv	osv

Applique con vetri opaline.
Wall light with opaline glass elements.



03-APP-229-U

dimensioni
dimensions

finiture
finishes

☺	NL	Wmax	Led	WLed	K°	V
---	----	------	-----	------	----	---

E27	1	40	-	-	-	220 - 240
-----	---	----	---	---	---	-----------

ØB	L	H	Ag
----	---	---	----

8,5 3 ¹¹ /32	20,5 8 ⁵ /64	15 5 ²⁹ /32	42,5 16 ⁴⁷ /64
---------------------------	---------------------------	--------------------------	-----------------------------

○	○	○	○	○	○	○	○	○	○	○	○	○	○	○
on	ov	ob	nl	ni	ns	nsv	cl	csv	al	asv	nelv	nesv	olv	osv

Applique con ventola in lamiera.
Wall light with sheet metal shade.



03-APP-227-U

dimensioni
dimensions

finiture
finishes

☺	NL	Wmax	Led	WLed	K°	V
---	----	------	-----	------	----	---

E27	1	40	-	-	-	220 - 240
-----	---	----	---	---	---	-----------

ØB	L	H	Ag
----	---	---	----

8,5 3 ¹¹ /32	12,5 4 ⁵⁹ /64	20 7 ⁷ /8	38,5 15 ⁵ /32
---------------------------	----------------------------	------------------------	----------------------------

○	○	○	○	○	○	○	○	○	○	○	○	○	○	○
on	ov	ob	nl	ni	ns	nsv	cl	csv	al	asv	nelv	nesv	olv	osv

Applique con vetro sabbato e molato.
Wall light with sandblasted/beveled glass.



03-APP-228-U

dimensioni
dimensions

finiture
finishes

☺	NL	Wmax	Led	WLed	K°	V
---	----	------	-----	------	----	---

E27	1	40	-	-	-	220 - 240
-----	---	----	---	---	---	-----------

ØB	L	H	Ag
----	---	---	----

8,5 3 ¹¹ /32	17,5 6 ⁵⁷ /64	16,5 6 ¹ /2	40,5 15 ¹⁵ /16
---------------------------	----------------------------	--------------------------	-----------------------------

○	○	○	○	○	○	○	○	○	○	○	○	○	○	○
on	ov	ob	nl	ni	ns	nsv	cl	csv	al	asv	nelv	nesv	olv	osv

Applique con vetro opaline.
Wall light with opaline glass.



03-APP-226-U

dimensioni
dimensions

finiture
finishes

Icona	NL	Wmax	Led	WLed	K°	V
-------	----	------	-----	------	----	---

E27	1	60	-	-	-	220 - 240
-----	---	----	---	---	---	-----------

ØB	L	H	Ag
8,5 3 ¹¹ /32	25 9 ²⁷ /32	12 4 ²³ /32	44,5 17 ³³ /6

<input type="radio"/>	<input type="radio"/>	<input type="radio"/>	<input type="radio"/>	<input type="radio"/>	<input type="radio"/>	<input type="radio"/>	<input type="radio"/>	<input type="radio"/>	<input type="radio"/>	<input type="radio"/>	<input type="radio"/>	<input type="radio"/>	<input type="radio"/>	<input type="radio"/>
on	ov	ob	nl	ni	ns	nsv	cl	csv	al	asv	nelv	nesv	olv	osv

Applique con piatto in lamiera smaltato.
Wall light with enameled sheet metal dish.



03-APP-030-U

dimensioni
dimensions

finiture
finishes

Icona	NL	Wmax	Led	WLed	K°	V
-------	----	------	-----	------	----	---

E14	1	40	-	-	-	220 - 240
-----	---	----	---	---	---	-----------

ØB	L	H	Ag
10,5 4 ⁹ /64	23 9 ¹ /16	31 12 ¹³ /64	43 16 ⁵⁹ /64

<input type="radio"/>	<input type="radio"/>	<input type="radio"/>	<input type="radio"/>	<input type="radio"/>	<input type="radio"/>	<input type="radio"/>	<input type="radio"/>	<input type="radio"/>	<input type="radio"/>	<input type="radio"/>	<input type="radio"/>	<input type="radio"/>	<input type="radio"/>	<input type="radio"/>
on	ov	ob	nl	ni	ns	nsv	cl	csv	al	asv	nelv	nesv	olv	osv

Applique in ferro e ottone con piatto in alluminio e vetro trasparente.
Iron and brass wall light with aluminum dish and transparent glass.



03-APP-079-U

03-APP-080-U

dimensioni
dimensions

finiture
finishes

Icona	NL	Wmax	Led	WLed	K°	V
-------	----	------	-----	------	----	---

-	-	-	LED	5	3000	24
-	-	-	LED	5	4000	24

FxG	L	H	Ag
11x12 4 ²¹ /64 x 4 ²³ /32	30 11 ¹³ /16	12 4 ²³ /32	25 9 ²⁷ /32

<input type="radio"/>	<input type="radio"/>	<input type="radio"/>	<input type="radio"/>	<input type="radio"/>	<input type="radio"/>	<input type="radio"/>	<input type="radio"/>	<input type="radio"/>	<input type="radio"/>	<input type="radio"/>	<input type="radio"/>	<input type="radio"/>	<input type="radio"/>	<input type="radio"/>
on	ov	ob	nl	ni	ns	nsv	cl	csv	al	asv	nelv	nesv	olv	osv

Applique.
Wall light.



	☰	NL	Wmax	Led	WLed	K°	V
03-APP-116-S	E14	1	40	-	-	-	220 - 240
03-APP-117-S	-	-	-	✓	2,5	3000	24
03-APP-118-S	-	-	-	✓	2,5	4000	24

dimensioni
dimensions

ØB	L	H	Ag
6 2 ²³ /64	21 8 ¹⁷ /64	12 4 ²³ /32	19 7 ³¹ /64

finiture
finishes

○	○	○	○	○	○	○	○	○	○	○	○	○	○	○
on	ov	ob	nl	ni	ns	nsv	cl	csv	al	asv	nelv	nesv	olv	osv

Applique.
Wall light.



	☰	NL	Wmax	Led	WLed	K°	V
03-APP-116-L	E14	2	40	-	-	-	220 - 240
03-APP-117-L	-	-	-	✓	5	3000	24
03-APP-118-L	-	-	-	✓	5	4000	24

dimensioni
dimensions

ØB	L	H	Ag
6 2 ²³ /64	38 14 ⁶¹ /64	12,5 4 ⁵⁹ /64	19,5 7 ⁴³ /64

finiture
finishes

○	○	○	○	○	○	○	○	○	○	○	○	○	○	○
on	ov	ob	nl	ni	ns	nsv	cl	csv	al	asv	nelv	nesv	olv	osv

Applique.
Wall light.



	☰	NL	Wmax	Led	WLed	K°	V
03-APP-121-U	E14	4	25	-	-	-	220 - 240
03-APP-122-U	-	-	-	✓	10	3000	24
03-APP-123-U	-	-	-	✓	10	4000	24

dimensioni
dimensions

ØB	L	H	Ag
6 2 ²³ /64	63 24 ⁵¹ /64	22 8 ²¹ /32	26 10 ¹⁵ /64

finiture
finishes

<input type="radio"/>	<input type="radio"/>	<input type="radio"/>	<input type="radio"/>	<input type="radio"/>	<input type="radio"/>	<input type="radio"/>	<input type="radio"/>	<input type="radio"/>	<input type="radio"/>	<input type="radio"/>	<input type="radio"/>	<input type="radio"/>	<input type="radio"/>	<input type="radio"/>	<input type="radio"/>
on	ov	ob	nl	ni	ns	nsv	cl	csv	al	asv	nelv	nesv	olv	osv	

Applique. (Interasse attaches a muro 29,5 cm)
Wall light. (space between wall attachments 29.5 cm)



	☰	NL	Wmax	Led	WLed	K°	V
03-APP-217-U	E14	1	40	-	-	-	220 - 240
03-APP-218-U	-	-	-	✓	2,5	3000	24
03-APP-219-U	-	-	-	✓	2,5	4000	24

dimensioni
dimensions

FxG	L	H	Ag
5x16 1 ³¹ /32 x 6 ¹⁹ /64	18,5 7 ⁹ /32	20 7 ⁷ /8	37 14 ⁹ /16

finiture
finishes

<input type="radio"/>	<input type="radio"/>	<input type="radio"/>	<input type="radio"/>	<input type="radio"/>	<input type="radio"/>	<input type="radio"/>	<input type="radio"/>	<input type="radio"/>	<input type="radio"/>	<input type="radio"/>	<input type="radio"/>	<input type="radio"/>	<input type="radio"/>	<input type="radio"/>	<input type="radio"/>
on	ov	ob	nl	ni	ns	nsv	cl	csv	al	asv	nelv	nesv	olv	osv	

Applique con gancio per quadro.
Wall light with hook for attaching painting.



03-APP-220-U

dimensioni
dimensions

finiture
finishes

	NL	Wmax	Led	WLed	K°	V
E14	1	40	-	-	-	220 - 240

L	H	Ag
18,5 7 ⁹ / ₃₂	20 7 ⁷ / ₈	38 14 ⁶¹ / ₆₄

<input type="radio"/>	<input type="radio"/>	<input type="radio"/>	<input type="radio"/>	<input type="radio"/>	<input type="radio"/>	<input type="radio"/>	<input type="radio"/>	<input type="radio"/>	<input type="radio"/>	<input type="radio"/>	<input type="radio"/>	<input type="radio"/>	<input type="radio"/>	<input type="radio"/>
on	ov	ob	nl	ni	ns	nsv	cl	csv	al	asv	nelv	nesv	olv	osv

Applique con morsetto.
Wall light with clamp.



03-APP-291-U

dimensioni
dimensions

finiture
finishes

	NL	Wmax	Led	WLed	K°	V
-	-	-	✓	-	-	220 - 240

ØB	L	H	Ag
11,5x5,5 4 ¹⁷ / ₃₂ x 2 ¹¹ / ₆₄	35 13 ²⁵ / ₃₂	13 5 ¹ / ₈	20,5 8 ⁵ / ₆₄

<input type="radio"/>	<input type="radio"/>	<input type="radio"/>	<input type="radio"/>	<input type="radio"/>	<input type="radio"/>	<input type="radio"/>	<input type="radio"/>	<input type="radio"/>	<input type="radio"/>	<input type="radio"/>	<input type="radio"/>	<input type="radio"/>	<input type="radio"/>	<input type="radio"/>
on	ov	ob	nl	ni	ns	nsv	cl	csv	al	asv	nelv	nesv	olv	osv

Applique.
Wall light.



03-APP-081-U

dimensioni
dimensions

finiture
finishes

	NL	Wmax	Led	WLed	K°	V
E27	1	60	-	-	-	220 - 240

ØB	L	H	Ag
9,5 3 ⁴⁷ / ₆₄	13,5 5 ⁵ / ₁₆	20 7 ⁷ / ₈	31 12 ¹³ / ₆₄

<input type="radio"/>	<input type="radio"/>	<input type="radio"/>	<input type="radio"/>	<input type="radio"/>	<input type="radio"/>	<input type="radio"/>	<input type="radio"/>	<input type="radio"/>	<input type="radio"/>	<input type="radio"/>	<input type="radio"/>	<input type="radio"/>	<input type="radio"/>	<input type="radio"/>
on	ov	ob	nl	ni	ns	nsv	cl	csv	al	asv	nelv	nesv	olv	osv

Applique estensibile con ventola in lamiera.
Extensible wall light with sheet metal shade.



03-APP-292-U

dimensioni
dimensions

finiture
finishes

	NL	Wmax	Led	WLed	K°	V								
E14	1	40	-	-	-	220 - 240								
ØB		L	H	Ag										
10 3 ¹⁵ /16		19,5 7 ⁴³ /64	32 12 ¹⁹ /32	50 19 ¹¹ /16										
○ on	○ ov	○ ob	○ nl	○ ni	○ ns	○ nsv	○ cl	○ csv	○ al	○ asv	○ nelv	○ nesv	○ olv	○ osv

Applique estensibile con ventola in lamiera.
Extensible wall light with sheet metal shade.



03-APP-016-U

dimensioni
dimensions

finiture
finishes

	NL	Wmax	Led	WLed	K°	V								
E27	1	60	-	-	-	220 - 240								
FxG		L	H	Ag										
8x11 3 ⁵ /32 x 4 ²¹ /64		15,5 6 ⁷ /64	39 15 ²³ /64	51 20 ⁵ /64										
○ on	○ ov	○ ob	○ nl	○ ni	○ ns	○ nsv	○ cl	○ csv	○ al	○ asv	○ nelv	○ nesv	○ olv	○ osv

Applique.
Wall light.



03-APP-280-U

dimensioni
dimensions

finiture
finishes

	NL	Wmax	Led	WLed	K°	V								
E14	1	40	-	-	-	220 - 240								
FxG		L	H	Ag										
4x10 1 ³⁷ /64 x 3 ¹⁵ /16		15,5 6 ⁷ /64	20 7 ⁷ /8	52 20 ¹⁵ /32										
○ on	○ ov	○ ob	○ nl	○ ni	○ ns	○ nsv	○ cl	○ csv	○ al	○ asv	○ nelv	○ nesv	○ olv	○ osv

Applique estensibile.
(Fotografata e misurata con paralume 03-ACC-262-U).
Extensible wall light.
(Photographed and measured with lampshade 03-ACC-262-U)



03-APP-286-U

Socket	NL	Wmax	Led	WLed	K°	V
E14	1	40	-	-	-	220 - 240

dimensioni
dimensions

FxG	L	H	Ag
4x10 1 ³⁷ / ₆₄ x 3 ¹⁵ / ₁₆	15,5 6 ⁷ / ₆₄	20 7 ⁷ / ₈	52 20 ¹⁵ / ₃₂

finiture
finishes

<input type="radio"/>	<input type="radio"/>	<input type="radio"/>	<input type="radio"/>	<input type="radio"/>	<input type="radio"/>	<input type="radio"/>	<input type="radio"/>	<input type="radio"/>	<input type="radio"/>	<input type="radio"/>	<input type="radio"/>	<input type="radio"/>	<input type="radio"/>	<input type="radio"/>
on	ov	ob	nl	ni	ns	nsv	cl	csv	al	asv	nelv	nesv	olv	osv

Applique estensibile con ventola in lamiera.
Extensible wall light with sheet metal shade.



03-APP-215-U

Socket	NL	Wmax	Led	WLed	K°	V
E27	1	60	-	-	-	220 - 240

dimensioni
dimensions

FxG	L	H	Ag
5,5x15,5 2 ¹¹ / ₆₄ x 6 ⁷ / ₆₄	29 11 ²⁷ / ₆₄	22 8 ²¹ / ₂₂	83 32 ⁴³ / ₆₄

finiture
finishes

<input type="radio"/>	<input type="radio"/>	<input type="radio"/>	<input type="radio"/>	<input type="radio"/>	<input type="radio"/>	<input type="radio"/>	<input type="radio"/>	<input type="radio"/>	<input type="radio"/>	<input type="radio"/>	<input type="radio"/>	<input type="radio"/>	<input type="radio"/>	<input type="radio"/>
on	ov	ob	nl	ni	ns	nsv	cl	csv	al	asv	nelv	nesv	olv	osv

Applique estensibile con vetro opaline.
Extensible wall light with opaline glass.



03-APP-216-U

Socket	NL	Wmax	Led	WLed	K°	V
E27	1	60	-	-	-	220 - 240

dimensioni
dimensions

FxG	L	H	Ag
5,5x15,5 2 ¹¹ / ₆₄ x 6 ⁷ / ₆₄	25 9 ²⁷ / ₃₂	26 10 ¹⁵ / ₁₆	81 31 ⁵⁷ / ₆₄

finiture
finishes

<input type="radio"/>	<input type="radio"/>	<input type="radio"/>	<input type="radio"/>	<input type="radio"/>	<input type="radio"/>	<input type="radio"/>	<input type="radio"/>	<input type="radio"/>	<input type="radio"/>	<input type="radio"/>	<input type="radio"/>	<input type="radio"/>	<input type="radio"/>	<input type="radio"/>
on	ov	ob	nl	ni	ns	nsv	cl	csv	al	asv	nelv	nesv	olv	osv

Applique estensibile con ventola in lamiera.
Extensible wall light with sheet metal shade.



03-APP-017-U

dimensioni
dimensions

finiture
finishes

	NL	Wmax	Led	WLed	K°	V
E14	1	40	-	-	-	220 - 240
ØB		L	H	Ag		
9 3 ³⁵ /64		27 10 ⁵ /8	18 7 ³ /32	28 11 ¹ /32		
○	○	○	○	○	○	○
on	ov	ob	nl	ni	ns	nsv
○	○	○	○	○	○	○
cl	csv	al	asv	nelv	nesv	olv
○	○	○	○	○	○	○
osv						

Applique.
Wall light.



03-APP-265-U

dimensioni
dimensions

finiture
finishes

	NL	Wmax	Led	WLed	K°	V
E27	1	40	-	-	-	220 - 240
FxG		L	H	Ag		
28,2x4,5 11 ⁷ /64 x 1 ⁴⁹ /64		28,2 11 ⁷ /64	30,5 12 ¹ /64	23 9 ¹ /16		
○	○	○	○	○	○	○
on	ov	ob	nl	ni	ns	nsv
○	○	○	○	○	○	○
cl	csv	al	asv	nelv	nesv	olv
○	○	○	○	○	○	○
osv						

Applique.
(Fotografata e misurata con paralume 03-ACC-266-U).
Wall light.
(Photographed and measured with lampshade 03-ACC-266-U).



03-APP-131-U

dimensioni
dimensions

finiture
finishes

	NL	Wmax	Led	WLed	K°	V
E14	1	40	-	-	-	220 - 240
FxG		L	H	Ag		
7x10,5 2 ³ /4 x 4 ⁹ /64		12,5 4 ⁵⁹ /64	21 8 ¹⁷ /64	21,5 8 ¹⁵ /32		
○	○	○	○	○	○	○
on	ov	ob	nl	ni	ns	nsv
○	○	○	○	○	○	○
cl	csv	al	asv	nelv	nesv	olv
○	○	○	○	○	○	○
osv						

Applique.
(Fotografata e misurata con paralume 03-ACC-258-U).
Wall light
(Photographed and measured with lampshade 03-ACC-258-U)



03-APP-186-U

NL Wmax Led WLed K° V

E27 1 40 - - - 220 - 240

dimensioni
dimensions

ØB L H Ag

12 | 4²³/32 18 | 7³/32 26,5 | 10⁷/16 26 | 10¹⁵/64

finiture
finishes

Applique.
Wall light.

NL Wmax Led WLed K° V

03-APP-187-U

- - - 220 - 240

dimensioni
dimensions

ØB H Ag

finiture
finishes

Applique.
Wall light..



03-APP-211-U

NL Wmax Led WLed K° V

E27 1 40 - - - 220 - 240

dimensioni
dimensions

FxG L H Ag

10x10 | 3¹⁵/16 x 3¹⁵/16 19,5 | 7⁴³/64 25 | 9²⁷/32 37,5 | 14⁴⁹/64

finiture
finishes

Applique con vetri opaline.
Wall light with opaline glass elements.



03-APP-212-U

dimensioni
dimensions

finiture
finishes

	NL	Wmax	Led	WLed	K°	V								
E14	2	40	-	-	-	220 - 240								
FxG	L		Ag											
12x4 4 ²³ / ₃₂ x 1 ³⁷ / ₆₄	36 14 ¹¹ / ₆₄		20 7 ⁷ / ₈											
○ on	○ ov	○ ob	○ nl	○ ni	○ ns	○ nsv	○ cl	○ csv	○ al	○ asv	○ nelv	○ nesv	○ olv	○ osv

Applique con vetri opaline.
Wall light with opaline glass elements.



03-APP-046-U

dimensioni
dimensions

finiture
finishes

	NL	Wmax	Led	WLed	K°	V								
E27	1	100	-	-	-	220 - 240								
ØB	L		H		Ag									
9 3 ³⁵ / ₆₄	40 15 ³ / ₄		65 25 ¹⁹ / ₃₂		100 39 ³ / ₈									
○ on	○ ov	○ ob	○ nl	○ ni	○ ns	○ nsv	○ cl	○ csv	○ al	○ asv	○ nelv	○ nesv	○ olv	○ osv

Lume estensibile.
(Fotografato e misurato con paralume 03-ACC-268-U)
Extensible lamp.
(Photographed and measured with lampshade 03-ACC-268-U)



03-APP-003-U

dimensioni
dimensions

finiture
finishes

	NL	Wmax	Led	WLed	K°	V								
BA15D	1	-	-	-	-	24								
	L		H		Ag									
	13 5 ¹ / ₈		7 2 ³ / ₄		4 1 ³⁷ / ₆₄									
○ on	○ ov	○ ob	○ nl	○ ni	○ ns	○ nsv	○ cl	○ csv	○ al	○ asv	○ nelv	○ nesv	○ olv	○ osv

Luce di lettura destra.
Right-hand reading light.



03-APP-004-U

dimensioni
dimensions

finiture
finishes

	NL	Wmax	Led	WLed	K°	V
--	----	------	-----	------	----	---

BA15D	1	-	-	-	-	24
-------	---	---	---	---	---	----

L	H	Ag
---	---	----

13 5 ¹ / ₈	7 2 ³ / ₄	4 1 ³⁷ / ₆₄
------------------------------------	-----------------------------------	-------------------------------------

<input type="radio"/>	<input type="radio"/>	<input type="radio"/>	<input type="radio"/>	<input type="radio"/>	<input type="radio"/>	<input type="radio"/>	<input type="radio"/>	<input type="radio"/>	<input type="radio"/>	<input type="radio"/>	<input type="radio"/>	<input type="radio"/>	<input type="radio"/>	<input type="radio"/>
on	ov	ob	nl	ni	ns	nsv	cl	csv	al	asv	nelv	nesv	olv	osv

Luce di lettura sinistra.
Left-hand reading light.

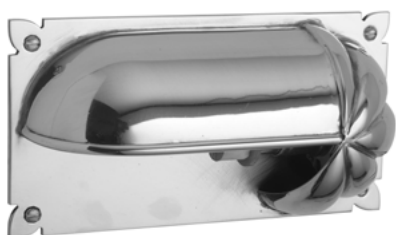

03-APP-005-U

dimensioni
dimensions

finiture
finishes

	NL	Wmax	Led	WLed	K°	V
--	----	------	-----	------	----	---

BA15D	1	-	-	-	-	24
-------	---	---	---	---	---	----

L	H	Ag
---	---	----

13 5 ¹ / ₈	7 2 ³ / ₄	3,5 1 ³ / ₈
------------------------------------	-----------------------------------	-------------------------------------

<input type="radio"/>	<input type="radio"/>	<input type="radio"/>	<input type="radio"/>	<input type="radio"/>	<input type="radio"/>	<input type="radio"/>	<input type="radio"/>	<input type="radio"/>	<input type="radio"/>	<input type="radio"/>	<input type="radio"/>	<input type="radio"/>	<input type="radio"/>	<input type="radio"/>
on	ov	ob	nl	ni	ns	nsv	cl	csv	al	asv	nelv	nesv	olv	osv

Luce di lettura destra.
Right-hand reading light.



03-APP-006-U

dimensioni
dimensions

finiture
finishes

	NL	Wmax	Led	WLed	K°	V
--	----	------	-----	------	----	---

BA15D	1	-	-	-	-	24
-------	---	---	---	---	---	----

L	H	Ag
---	---	----

13 5 ¹ / ₈	7 2 ³ / ₄	3,5 1 ³ / ₈
------------------------------------	-----------------------------------	-------------------------------------

<input type="radio"/>	<input type="radio"/>	<input type="radio"/>	<input type="radio"/>	<input type="radio"/>	<input type="radio"/>	<input type="radio"/>	<input type="radio"/>	<input type="radio"/>	<input type="radio"/>	<input type="radio"/>	<input type="radio"/>	<input type="radio"/>	<input type="radio"/>	<input type="radio"/>
on	ov	ob	nl	ni	ns	nsv	cl	csv	al	asv	nelv	nesv	olv	osv

Luce di lettura sinistra.
Left-hand reading light.





		NL	Wmax	Led	WLed	K°	V
03-PLA-041-S	E14	1	40	-	-	-	220-240
03-PLA-042-S	G9	2	-	✓	2,5	3000	220-240

dimensioni cm
dimension inches

ØB	H
21 8 ¹⁷ / ₆₄	9 3 ³⁵ / ₆₄

finiture
core finishes

<input type="radio"/>	<input type="radio"/>	<input type="radio"/>	<input type="radio"/>	<input type="radio"/>	<input type="radio"/>	<input type="radio"/>	<input type="radio"/>	<input type="radio"/>	<input type="radio"/>	<input type="radio"/>	<input type="radio"/>	<input type="radio"/>	<input type="radio"/>	<input type="radio"/>
on	ov	ob	nl	ni	ns	nsv	cl	csv	al	asv	nelv	nesv	olv	osv

Plafoniera con vetro sabbato.
Ceiling light with sandblasted glass.



		NL	Wmax	Led	WLed	K°	V
03-PLA-041-L	E14	1	40	-	-	-	220-240
03-PLA-042-L	G9	2	-	✓	2,5	3000	220-240

dimensioni cm
dimension inches

ØB	H
31 12 ¹³ / ₆₄	12 4 ²³ / ₃₂

finiture
core finishes

<input type="radio"/>	<input type="radio"/>	<input type="radio"/>	<input type="radio"/>	<input type="radio"/>	<input type="radio"/>	<input type="radio"/>	<input type="radio"/>	<input type="radio"/>	<input type="radio"/>	<input type="radio"/>	<input type="radio"/>	<input type="radio"/>	<input type="radio"/>	<input type="radio"/>
on	ov	ob	nl	ni	ns	nsv	cl	csv	al	asv	nelv	nesv	olv	osv

Plafoniera con vetro sabbato.
Ceiling light with sandblasted glass.



03-PLA-073-S
03-PLA-074-S

		NL	Wmax	Led	WLed	K°	V
03-PLA-073-S	E14	1	40	-	-	-	220-240
03-PLA-074-S	G9	2	-	✓	2,5	3000	220-240

dimensioni cm
dimension inches

ØB	H
21 8 ¹⁷ / ₆₄	9 3 ³⁵ / ₆₄

finiture
core finishes

<input type="radio"/>	<input type="radio"/>	<input type="radio"/>	<input type="radio"/>	<input type="radio"/>	<input type="radio"/>	<input type="radio"/>	<input type="radio"/>	<input type="radio"/>	<input type="radio"/>	<input type="radio"/>	<input type="radio"/>	<input type="radio"/>	<input type="radio"/>	<input type="radio"/>
on	ov	ob	nl	ni	ns	nsv	cl	csv	al	asv	nelv	nesv	olv	osv

Plafoniera con vetro sabbato.
Ceiling light with sandblasted glass.



03-PLA-073-L
03-PLA-074-L

		NL	Wmax	Led	WLed	K°	V
03-PLA-073-L	E14	1	40	-	-	-	220-240
03-PLA-074-L	G9	2	-	✓	2,5	3000	220-240

dimensioni cm
dimension inches

ØB	H
31 12 ¹³ / ₆₄	12 4 ²³ / ₃₂

finiture
core finishes

<input type="radio"/>	<input type="radio"/>	<input type="radio"/>	<input type="radio"/>	<input type="radio"/>	<input type="radio"/>	<input type="radio"/>	<input type="radio"/>	<input type="radio"/>	<input type="radio"/>	<input type="radio"/>	<input type="radio"/>	<input type="radio"/>	<input type="radio"/>	<input type="radio"/>
on	ov	ob	nl	ni	ns	nsv	cl	csv	al	asv	nelv	nesv	olv	osv

Plafoniera con vetro sabbato.
Ceiling light with sandblasted glass.



		NL	Wmax	Led	WLed	K°	V
03-PLA-085-U	E14	1	40	-	-	-	220-240
03-PLA-086-U	-	-	-	✓	6,5	3000	24
03-PLA-087-U	-	-	-	✓	6,5	4000	24

dimensioni cm
dimension inches

ØB	H
21,5 8 ¹⁵ /32	8 3 ⁵ /32

finiture
core finishes

<input type="radio"/>	<input type="radio"/>	<input type="radio"/>	<input type="radio"/>	<input type="radio"/>	<input type="radio"/>	<input type="radio"/>	<input type="radio"/>	<input type="radio"/>	<input type="radio"/>	<input type="radio"/>	<input type="radio"/>	<input type="radio"/>	<input type="radio"/>	<input type="radio"/>
on	ov	ob	nl	ni	ns	nsv	cl	csv	al	asv	nelv	nesv	olv	osv

Plafoniera con vetro sabbato e molato.
Ceiling light with sandblasted and beveled glass.



		NL	Wmax	Led	WLed	K°	V
03-PLA-200-U	E14	1	40	-	-	-	220-240
03-PLA-201-U	-	-	-	✓	6,5	3000	24
03-PLA-202-U	-	-	-	✓	6,5	4000	24

dimensioni cm
dimension inches

ØB	H
21,5 8 ¹⁵ /32	8 3 ⁵ /32

finiture
core finishes

<input type="radio"/>	<input type="radio"/>	<input type="radio"/>	<input type="radio"/>	<input type="radio"/>	<input type="radio"/>	<input type="radio"/>	<input type="radio"/>	<input type="radio"/>	<input type="radio"/>	<input type="radio"/>	<input type="radio"/>	<input type="radio"/>	<input type="radio"/>	<input type="radio"/>
on	ov	ob	nl	ni	ns	nsv	cl	csv	al	asv	nelv	nesv	olv	osv

Plafoniera con vetro sabbato e molato.
Ceiling light with sandblasted and beveled glass.



		NL	Wmax	Led	WLed	K°	V
03-PLA-221-U	E27	1	60	-	-	-	220-240
03-PLA-222-U	-	-	-	✓	6,5	3000	24
03-PLA-223-U	-	-	-	✓	6,5	4000	24

dimensioni cm
dimension inches

ØB	H
22,5 8 ⁵⁵ /64	9,5 3 ⁴⁷ /64

finiture
core finishes

<input type="radio"/>	<input type="radio"/>	<input type="radio"/>	<input type="radio"/>	<input type="radio"/>	<input type="radio"/>	<input type="radio"/>	<input type="radio"/>	<input type="radio"/>	<input type="radio"/>	<input type="radio"/>	<input type="radio"/>	<input type="radio"/>	<input type="radio"/>	<input type="radio"/>
on	ov	ob	nl	ni	ns	nsv	cl	csv	al	asv	nelv	nesv	olv	osv

Plafoniera con vetro sabbato e molato.
Ceiling light with sandblasted and beveled glass.



		NL	Wmax	Led	WLed	K°	V
03-PLA-019-U	E27	1	60	-	-	-	220-240
03-PLA-020-U	-	-	-	✓	6,5	3000	24
03-PLA-021-U	-	-	-	✓	6,5	4000	24
03-PLA-022-U	-	-	-	✓	13	3000	24
03-PLA-023-U	-	-	-	✓	13	4000	24

dimensioni cm
dimension inches

ØB	H
27,5 10 ⁵³ /64	17 6 ¹¹ /16

finiture
core finishes

<input type="radio"/>	<input type="radio"/>	<input type="radio"/>	<input type="radio"/>	<input type="radio"/>	<input type="radio"/>	<input type="radio"/>	<input type="radio"/>	<input type="radio"/>	<input type="radio"/>	<input type="radio"/>	<input type="radio"/>	<input type="radio"/>	<input type="radio"/>	<input type="radio"/>
on	ov	ob	nl	ni	ns	nsv	cl	csv	al	asv	nelv	nesv	olv	osv

Plafoniera con vetro sabbato e molato.
Ceiling light with sandblasted and beveled glass.



		NL	Wmax	Led	WLed	K°	V
03-PLA-051-S	E14	1	60	-	-	-	220-240
03-PLA-052-S	-	-	-	✓	6,5	3000	24
03-PLA-053-S	-	-	-	✓	6,5	4000	24
03-PLA-054-S	-	-	-	✓	13	3000	24
03-PLA-055-S	-	-	-	✓	13	4000	24

dimensioni cm
dimension inches

ØB	H
22 8 ²¹ / ₃₂	15 5 ²⁹ / ₃₂

finiture
core finishes

<input type="radio"/>	<input type="radio"/>	<input type="radio"/>	<input type="radio"/>	<input type="radio"/>	<input type="radio"/>	<input type="radio"/>	<input type="radio"/>	<input type="radio"/>	<input type="radio"/>	<input type="radio"/>	<input type="radio"/>	<input type="radio"/>	<input type="radio"/>	<input type="radio"/>
on	ov	ob	nl	ni	ns	nsv	cl	csv	al	asv	nelv	nesv	olv	osv

Plafoniera con vetro sabbato e molato.
Ceiling light with sandblasted and beveled glass.



		NL	Wmax	Led	WLed	K°	V
03-PLA-051-L	E27	1	60	-	-	-	220-240
03-PLA-052-L	-	-	-	✓	6,5	3000	24
03-PLA-053-L	-	-	-	✓	6,5	4000	24
03-PLA-054-L	-	-	-	✓	13	3000	24
03-PLA-055-L	-	-	-	✓	13	4000	24

dimensioni cm
dimension inches

ØB	H
31,5 12 ¹³ / ₃₂	19 7 ³¹ / ₆₄

finiture
core finishes

<input type="radio"/>	<input type="radio"/>	<input type="radio"/>	<input type="radio"/>	<input type="radio"/>	<input type="radio"/>	<input type="radio"/>	<input type="radio"/>	<input type="radio"/>	<input type="radio"/>	<input type="radio"/>	<input type="radio"/>	<input type="radio"/>	<input type="radio"/>	<input type="radio"/>
on	ov	ob	nl	ni	ns	nsv	cl	csv	al	asv	nelv	nesv	olv	osv

Plafoniera con vetro sabbato e molato.
Ceiling light with sandblasted and beveled glass.



		NL	Wmax	Led	WLed	K°	V
03-PLA-107-U	E27	1	60	-	-	-	220-240
03-PLA-108-U	-	-	-	✓	6,5	3000	24
03-PLA-109-U	-	-	-	✓	6,5	4000	24
03-PLA-110-U	-	-	-	✓	13	3000	24
03-PLA-111-U	-	-	-	✓	13	4000	24

dimensioni cm
dimension inches

ØB	H
27,5 10 ⁵³ / ₆₄	16 6 ¹⁹ / ₆₄

finiture
core finishes

<input type="radio"/>	<input type="radio"/>	<input type="radio"/>	<input type="radio"/>	<input type="radio"/>	<input type="radio"/>	<input type="radio"/>	<input type="radio"/>	<input type="radio"/>	<input type="radio"/>	<input type="radio"/>	<input type="radio"/>	<input type="radio"/>	<input type="radio"/>	<input type="radio"/>
on	ov	ob	nl	ni	ns	nsv	cl	csv	al	asv	nelv	nesv	olv	osv

Plafoniera con vetro sabbato e molato.
Ceiling light with sandblasted and beveled glass.



		NL	Wmax	Led	WLed	K°	V
03-PLA-144-U	E27	1	40	-	-	-	220-240
03-PLA-145-U	-	-	-	✓	6,5	3000	24
03-PLA-146-U	-	-	-	✓	6,5	4000	24
03-PLA-147-U	-	-	-	✓	13	3000	24
03-PLA-148-U	-	-	-	✓	13	4000	24

dimensioni cm
dimension inches

ØB	H
19 7 ³¹ / ₆₄	20 7 ⁷ / ₈

finiture
core finishes

<input type="radio"/>	<input type="radio"/>	<input type="radio"/>	<input type="radio"/>	<input type="radio"/>	<input type="radio"/>	<input type="radio"/>	<input type="radio"/>	<input type="radio"/>	<input type="radio"/>	<input type="radio"/>	<input type="radio"/>	<input type="radio"/>	<input type="radio"/>	<input type="radio"/>
on	ov	ob	nl	ni	ns	nsv	cl	csv	al	asv	nelv	nesv	olv	osv

Plafoniera con vetro sabbato e molato.
Ceiling light with sandblasted and beveled glass.



		NL	Wmax	Led	WLed	K°	V
03-PLA-237-U	E27	1	40	-	-	-	220-240
03-PLA-238-U	-	-	-	✓	6,5	3000	24
03-PLA-239-U	-	-	-	✓	6,5	4000	24
03-PLA-240-U	-	-	-	✓	13	3000	24
03-PLA-241-U	-	-	-	✓	13	4000	24

dimensioni cm
dimension inches

ØB	H
19 7 ³¹ / ₆₄	20 7 ⁷ / ₈

finiture
core finishes

<input type="radio"/>	<input type="radio"/>	<input type="radio"/>	<input type="radio"/>	<input type="radio"/>	<input type="radio"/>	<input type="radio"/>	<input type="radio"/>	<input type="radio"/>	<input type="radio"/>	<input type="radio"/>	<input type="radio"/>	<input type="radio"/>	<input type="radio"/>	<input type="radio"/>
on	ov	ob	nl	ni	ns	nsv	cl	csv	al	asv	nelv	nesv	olv	osv

Plafoniera con vetro opaline.
Ceiling light with opaline glass.



		NL	Wmax	Led	WLed	K°	V
03-PLA-082-U	-	-	-	✓	6,5	3000	24
03-PLA-083-U	-	-	-	✓	6,5	4000	24

dimensioni cm
dimension inches

ØB	H
13,5 5 ⁵ / ₁₆	6,5 2 ⁹ / ₁₆

finiture
core finishes

<input type="radio"/>	<input type="radio"/>	<input type="radio"/>	<input type="radio"/>	<input type="radio"/>	<input type="radio"/>	<input type="radio"/>	<input type="radio"/>	<input type="radio"/>	<input type="radio"/>	<input type="radio"/>	<input type="radio"/>	<input type="radio"/>	<input type="radio"/>	<input type="radio"/>
on	ov	ob	nl	ni	ns	nsv	cl	csv	al	asv	nelv	nesv	olv	osv

Plafoniera con vetro sabbato e molato.
Ceiling light with sandblasted and beveled glass.



03-PLA-274-U

	NL	Wmax	Led	WLed	K°	V
G9	2	-	✓	2,5	3000	220-240

dimensioni cm
dimension inches

ØB	H
14 5 ³³ / ₆₄	5,7 2 ¹ / ₄

finiture
core finishes

<input type="radio"/>	<input type="radio"/>	<input type="radio"/>	<input type="radio"/>	<input type="radio"/>	<input type="radio"/>	<input type="radio"/>	<input type="radio"/>	<input type="radio"/>	<input type="radio"/>	<input type="radio"/>	<input type="radio"/>	<input type="radio"/>	<input type="radio"/>	<input type="radio"/>
on	ov	ob	nl	ni	ns	nsv	cl	csv	al	asv	nelv	nesv	olv	osv

Plafoniera con vetro sabbato.
Ceiling light with sandblasted glass.

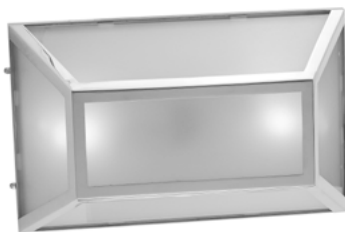

03-PLA-293-U

	NL	Wmax	Led	WLed	K°	V
E14	2	40	-	-	-	220-240

dimensioni cm
dimension inches

FxG	H
25x40 9 ²⁷ / ₃₂ X 15 ³ / ₄	12,5 4 ⁵⁹ / ₆₄

finiture
core finishes

<input type="radio"/>	<input type="radio"/>	<input type="radio"/>	<input type="radio"/>	<input type="radio"/>	<input type="radio"/>	<input type="radio"/>	<input type="radio"/>	<input type="radio"/>	<input type="radio"/>	<input type="radio"/>	<input type="radio"/>	<input type="radio"/>	<input type="radio"/>	<input type="radio"/>
on	ov	ob	nl	ni	ns	nsv	cl	csv	al	asv	nelv	nesv	olv	osv

Plafoniera con vetro opaline.
Ceiling light with opaline glass.

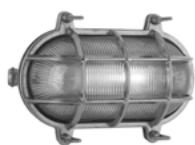

03-PLA-179-S
03-PLA-289-S

dimensioni cm
dimension inches

	NL	Wmax	Led	WLed	K°	V
E27	1	42	-	-	-	220 - 240
-	-	-	✓	9	3000	220 - 240

FxG	Ag
17x13 6 ¹¹ / ₁₆ x 5 ¹ / ₈	10,5 4 ⁹ / ₆₄

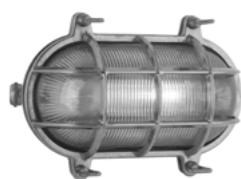

03-PLA-179-M
03-PLA-289-M

dimensioni cm
dimension inches

	NL	Wmax	Led	WLed	K°	V
E27	1	52	-	-	-	220 - 240
-	-	-	✓	9	3000	220 - 240

FxG	Ag
20x14 7 ⁷ / ₈ x 5 ³³ / ₆₄	11 4 ²¹ / ₆₄

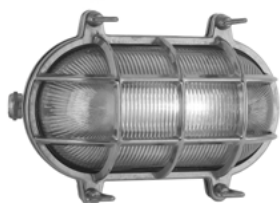

03-PLA-179-L
03-PLA-289-L

dimensioni cm
dimension inches

	NL	Wmax	Led	WLed	K°	V
E27	1	60	-	-	-	220 - 240
-	-	-	✓	13	3000	220 - 240

FxG	Ag
23x16,5 9 ¹ / ₁₆ x 6 ¹ / ₂	11 4 ²¹ / ₆₄

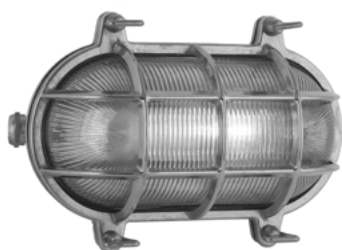

03-PLA-179-XL
03-PLA-289-XL

dimensioni cm
dimension inches

	NL	Wmax	Led	WLed	K°	V
E27	1	77	-	-	-	220 - 240
-	-	-	✓	18	3000	220 - 240

FxG	Ag
26x20 10 ¹⁵ / ₆₄ x 7 ⁷ / ₈	15 5 ²⁹ / ₃₂

finiture
core finishes



Plafoniera con vetro trasparente.
Ceiling light with transparent glass.

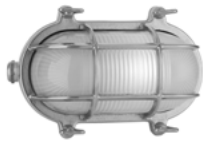

03-PLA-180-S
03-PLA-290-S

dimensioni cm
dimension inches

	NL	Wmax	Led	WLed	K°	V
E27	1	42	-	-	-	220 - 240
-	-	-	✓	9	3000	220 - 240

FxG	Ag
17x13 6 ¹¹ / ₁₆ x 5 ¹ / ₈	10,5 4 ⁹ / ₆₄

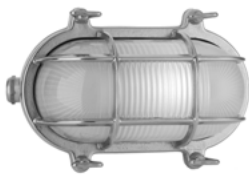

03-PLA-180-M
03-PLA-290-M

dimensioni cm
dimension inches

	NL	Wmax	Led	WLed	K°	V
E27	1	52	-	-	-	220 - 240
-	-	-	✓	9	3000	220 - 240

FxG	Ag
20x14 7 ⁷ / ₈ x 5 ³³ / ₆₄	11 4 ²¹ / ₆₄

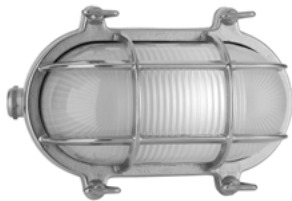

03-PLA-180-L
03-PLA-290-L

dimensioni cm
dimension inches

	NL	Wmax	Led	WLed	K°	V
E27	1	60	-	-	-	220 - 240
-	-	-	✓	13	3000	220 - 240

FxG	Ag
23x16,5 9 ¹ / ₁₆ x 6 ¹ / ₂	11 4 ²¹ / ₆₄

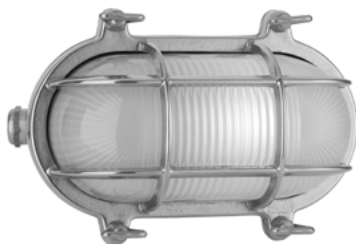

03-PLA-180-XL
03-PLA-290-XL

dimensioni cm
dimension inches

	NL	Wmax	Led	WLed	K°	V
E27	1	77	-	-	-	220 - 240
-	-	-	✓	18	3000	220 - 240

FxG	Ag
26x20 10 ¹⁵ / ₆₄ x 7 ⁷ / ₈	15 5 ²⁹ / ₃₂

finiture
core finishes

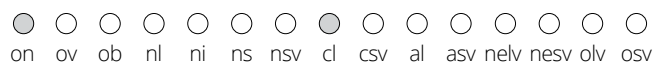

Plafoniera con vetro sabbato.
Ceiling light with sandblasted glass.



03-PLA-096-U

	NL	Wmax	Led	WLed	K°	V
E27	1	60	-	-	-	220-240

dimensioni cm
dimension inches

FxG	Ag
28,5x15 11 ⁷ / ₃₂ x 5 ²⁹ / ₃₂	2,5 0 ⁶³ / ₆₄

finiture
core finishes

<input type="radio"/>	<input type="radio"/>	<input type="radio"/>	<input type="radio"/>	<input type="radio"/>	<input type="radio"/>	<input type="radio"/>	<input type="radio"/>	<input type="radio"/>	<input type="radio"/>	<input type="radio"/>	<input type="radio"/>	<input type="radio"/>	<input type="radio"/>	<input type="radio"/>
on	ov	ob	nl	ni	ns	nsv	cl	csv	al	asv	nelv	nesv	olv	osv

Plafoniera da incasso. Misure incasso 27,5x14,5x8 cm.
Built-in ceiling light. Built-in measurements 27.5x14.5x 8 cm.



03-PLA-168-U

	NL	Wmax	Led	WLed	K°	V
E27	1	52	-	-	-	220-240

dimensioni cm
dimension inches

ØB	Ag
21 8 ¹⁷ / ₆₄	11 4 ²¹ / ₆₄

finiture
core finishes

<input type="radio"/>	<input type="radio"/>	<input type="radio"/>	<input type="radio"/>	<input type="radio"/>	<input type="radio"/>	<input type="radio"/>	<input type="radio"/>	<input type="radio"/>	<input type="radio"/>	<input type="radio"/>	<input type="radio"/>	<input type="radio"/>	<input type="radio"/>	<input type="radio"/>
on	ov	ob	nl	ni	ns	nsv	cl	csv	al	asv	nelv	nesv	olv	osv

Plafoniera da esterno con vetro trasparente.
Outdoor ceiling light with transparent glass.





03-LAN-164-U

	NL	Wmax	Led	WLed	K°	V
E14	2	40	-	-	-	220 - 240

dimensioni
dimensions

RxS	H
27,5x35 10 ⁵³ /64 x 13 ²⁵ /32	40 15 ³ /4

finiture
finishes

<input type="radio"/>	<input type="radio"/>	<input type="radio"/>	<input type="radio"/>	<input type="radio"/>	<input type="radio"/>	<input type="radio"/>	<input type="radio"/>	<input type="radio"/>	<input type="radio"/>	<input type="radio"/>	<input type="radio"/>	<input type="radio"/>	<input type="radio"/>	<input type="radio"/>
on	ov	ob	nl	ni	ns	nsv	cl	csv	al	asv	nelv	nesv	olv	osv

Lanterna a sospensione.
Misure riportate esclusa catena.
Wall light with opaline glass.
Measurements given excluding chain.



03-LAN-040-U

	NL	Wmax	Led	WLed	K°	V
E27	1	60	-	-	-	220 - 240

dimensioni
dimensions

ØI	H
30 11 ¹³ /16	55 21 ²¹ /32

finiture
finishes

<input type="radio"/>	<input type="radio"/>	<input type="radio"/>	<input type="radio"/>	<input type="radio"/>	<input type="radio"/>	<input type="radio"/>	<input type="radio"/>	<input type="radio"/>	<input type="radio"/>	<input type="radio"/>	<input type="radio"/>	<input type="radio"/>	<input type="radio"/>	<input type="radio"/>
on	ov	ob	nl	ni	ns	nsv	cl	csv	al	asv	nelv	nesv	olv	osv

Lanterna a sospensione con vetro trasparente.
Misure riportate esclusa catena.
Hanging lantern with transparent glass.
Measurements given excluding chain.



03-LAN-090-U

	NL	Wmax	Led	WLed	K°	V
E27	1	100	-	-	-	220 - 240

dimensioni
dimensions

RxS	H
36x36 14 ¹¹ /64 x 14 ¹¹ /64	55 21 ²¹ /32

finiture
finishes

<input type="radio"/>	<input type="radio"/>	<input type="radio"/>	<input type="radio"/>	<input type="radio"/>	<input type="radio"/>	<input type="radio"/>	<input type="radio"/>	<input type="radio"/>	<input type="radio"/>	<input type="radio"/>	<input type="radio"/>	<input type="radio"/>	<input type="radio"/>	<input type="radio"/>
on	ov	ob	nl	ni	ns	nsv	cl	csv	al	asv	nelv	nesv	olv	osv

Lanterna a sospensione.
Misure riportate esclusa catena.
Wall light with opaline glass.
Measurements given excluding chain.



03-LAN-154-U

	NL	Wmax	Led	WLed	K°	V
E14	1	60	-	-	-	220 - 240

dimensioni
dimensions

L	H	Ag
25 9 ²⁷ /32	33 12 ⁶³ /64	11 4 ²¹ /64

finiture
finishes

<input type="radio"/>	<input type="radio"/>	<input type="radio"/>	<input type="radio"/>	<input type="radio"/>	<input type="radio"/>	<input type="radio"/>	<input type="radio"/>	<input type="radio"/>	<input type="radio"/>	<input type="radio"/>	<input type="radio"/>	<input type="radio"/>	<input type="radio"/>	<input type="radio"/>
on	ov	ob	nl	ni	ns	nsv	cl	csv	al	asv	nelv	nesv	olv	osv

Lanterna da parete con specchio invecchiato.
Wall lantern with aged mirror.

03-LAN-097-U

	NL	Wmax	Led	WLed	K°	V
E27	1	60	-	-	-	220 - 240

dimensioni
dimensions

L	H	Ag
36 14 ¹¹ /64	55 21 ²¹ /32	19,5 7 ⁴³ /64

finiture
finishes

<input type="radio"/>	<input type="radio"/>	<input type="radio"/>	<input type="radio"/>	<input type="radio"/>	<input type="radio"/>	<input type="radio"/>	<input type="radio"/>	<input type="radio"/>	<input type="radio"/>	<input type="radio"/>	<input type="radio"/>	<input type="radio"/>	<input type="radio"/>	<input type="radio"/>
on	ov	ob	nl	ni	ns	nsv	cl	csv	al	asv	nelv	nesv	olv	osv

Lanterna da parete.
Wall lantern.

03-LAN-050-U

	NL	Wmax	Led	WLed	K°	V
			-	-	-	220 - 240

dimensioni
dimensions

ØB	L	H	Ag

finiture
finishes

<input type="radio"/>	<input type="radio"/>	<input type="radio"/>	<input type="radio"/>	<input type="radio"/>	<input type="radio"/>	<input type="radio"/>	<input type="radio"/>	<input type="radio"/>	<input type="radio"/>	<input type="radio"/>	<input type="radio"/>	<input type="radio"/>	<input type="radio"/>	<input type="radio"/>
on	ov	ob	nl	ni	ns	nsv	cl	csv	al	asv	nelv	nesv	olv	osv

Lanterna.
Wall lantern.



03-LAN-060-U

	NL	Wmax	Led	WLed	K°	V
E27	1	100	-	-	-	220 - 240

dimensioni
dimensions

L	H	Ag
33,5 13 ³ /16	58 22 ⁵³ /64	22 8 ²¹ /32

finiture
finishes

<input type="radio"/>	<input type="radio"/>	<input type="radio"/>	<input type="radio"/>	<input type="radio"/>	<input type="radio"/>	<input type="radio"/>	<input type="radio"/>	<input type="radio"/>	<input type="radio"/>	<input type="radio"/>	<input type="radio"/>	<input type="radio"/>	<input type="radio"/>	<input type="radio"/>
on	ov	ob	nl	ni	ns	nsv	cl	csv	al	asv	nelv	nesv	olv	osv

Lanterna a parete in ferro verniciato.
Painted iron wall lantern.



03-LAN-172-U

	NL	Wmax	Led	WLed	K°	V
E27	1	100	-	-	-	220 - 240

dimensioni
dimensions

RxS	H
35x35 13 ²⁵ /32 x 13 ²⁵ /32	70 27 ⁹ /16

finiture
finishes

<input type="radio"/>	<input type="radio"/>	<input type="radio"/>	<input type="radio"/>	<input type="radio"/>	<input type="radio"/>	<input type="radio"/>	<input type="radio"/>	<input type="radio"/>	<input type="radio"/>	<input type="radio"/>	<input type="radio"/>	<input type="radio"/>	<input type="radio"/>	<input type="radio"/>
on	ov	ob	nl	ni	ns	nsv	cl	csv	al	asv	nelv	nesv	olv	osv

Lanterna in ferro verniciato.
Painted iron lantern.





03-LAM-167-U

NL Wmax Led WLed K° V

E14 3 40 - - - 220 - 240

dimensioni
dimensions

ØI H
36 | 14¹¹/₆₄ 65 | 25¹⁹/₃₂

finiture
finishes

on ov ob nl ni ns nsv cl csv al asv nelv nesv olv osv

Lanterna a sospensione.
Misure riportate esclusa catena.
Wall light with opaline glass.
Measurements given excluding chain.

NL Wmax Led WLed K° V

03-LAM-155-U

E27 2 40 - - - 220 - 240

dimensioni
dimensions

ØB L H Ag

finiture
finishes

on ov ob nl ni ns nsv cl csv al asv nelv nesv olv osv

Lume saliscendi.
Sliding lamp.

NL Wmax Led WLed K° V

03-LAM-160-U

E14 4 40 - - - 220 - 240

dimensioni
dimensions

L H
98 | 38³⁷/₆₄ 75 | 29¹⁷/₃₂

finiture
finishes

on ov ob nl ni ns nsv cl csv al asv nelv nesv olv osv

Lampadario.
(Fotografato e misurato con paralumi 03-ACC-254-U)
Chandelier.
(Photographed and measured with lampshades 03-ACC-254-U).





03-LAM-161-U

	NL	Wmax	Led	WLed	K°	V
E27	4	40	-	-	-	220 - 240

dimensioni
dimensions

L	H
94 37 ¹ /64	75 29 ¹⁷ /32

finiture
finishes

<input type="radio"/>	<input type="radio"/>	<input type="radio"/>	<input type="radio"/>	<input type="radio"/>	<input type="radio"/>	<input type="radio"/>	<input type="radio"/>	<input type="radio"/>	<input type="radio"/>	<input type="radio"/>	<input type="radio"/>	<input type="radio"/>	<input type="radio"/>	<input type="radio"/>
on	ov	ob	nl	ni	ns	nsv	cl	csv	al	asv	nelv	nesv	olv	osv

Lampadario con vetri opaline.
Chandelier with opaline glass elements.



03-LAM-165-U

	NL	Wmax	Led	WLed	K°	V
E27	2	100	-	-	-	220 - 240

dimensioni
dimensions

L	H
129 50 ²⁵ /32	125 49 ⁷ /32

finiture
finishes

<input type="radio"/>	<input type="radio"/>	<input type="radio"/>	<input type="radio"/>	<input type="radio"/>	<input type="radio"/>	<input type="radio"/>	<input type="radio"/>	<input type="radio"/>	<input type="radio"/>	<input type="radio"/>	<input type="radio"/>	<input type="radio"/>	<input type="radio"/>	<input type="radio"/>
on	ov	ob	nl	ni	ns	nsv	cl	csv	al	asv	nelv	nesv	olv	osv

Lampadario.
(Fotografato e misurato con paralumi 03-ACC-268-U)
Chandelier.
(Photographed and measured with lampshades 03-ACC-268-U)



03-LAM-283-U

	NL	Wmax	Led	WLed	K°	V
E27	2	100	-	-	-	220 - 240

dimensioni
dimensions

L	H
118 46 ²⁹ /64	113 44 ³¹ /64

finiture
finishes

<input type="radio"/>	<input type="radio"/>	<input type="radio"/>	<input type="radio"/>	<input type="radio"/>	<input type="radio"/>	<input type="radio"/>	<input type="radio"/>	<input type="radio"/>	<input type="radio"/>	<input type="radio"/>	<input type="radio"/>	<input type="radio"/>	<input type="radio"/>	<input type="radio"/>
on	ov	ob	nl	ni	ns	nsv	cl	csv	al	asv	nelv	nesv	olv	osv

Lampadario.
(Fotografato e misurato con vetri 03-ACC-195-U)
Chandelier.
(Photographed and measured with glass elements 03-ACC-195-U)



03-LAM-099-U

	NL	Wmax	Led	WLed	K°	V
E27	2	100	-	-	-	220 - 240

dimensioni
dimensions

L	H
137 53 ¹⁵ /16	131 51 ³⁷ /64

finiture
finishes

<input type="radio"/>	<input type="radio"/>	<input type="radio"/>	<input type="radio"/>	<input type="radio"/>	<input type="radio"/>	<input type="radio"/>	<input type="radio"/>	<input type="radio"/>	<input type="radio"/>	<input type="radio"/>	<input type="radio"/>	<input type="radio"/>	<input type="radio"/>	<input type="radio"/>
on	ov	ob	nl	ni	ns	nsv	cl	csv	al	asv	nelv	nesv	olv	osv

Lampadario in rame e ottone.
(Fotografato e misurato con paralumi 03-ACC-268-U)
Copper and brass chandelier.
(Photographed and measured with lampshades 03-ACC-268-U)



03-LAM-284-U

	NL	Wmax	Led	WLed	K°	V
E27	2	100	-	-	-	220 - 240

dimensioni
dimensions

L	H
126 49 ³⁹ /64	123 48 ²⁷ /64

finiture
finishes

<input type="radio"/>	<input type="radio"/>	<input type="radio"/>	<input type="radio"/>	<input type="radio"/>	<input type="radio"/>	<input type="radio"/>	<input type="radio"/>	<input type="radio"/>	<input type="radio"/>	<input type="radio"/>	<input type="radio"/>	<input type="radio"/>	<input type="radio"/>	<input type="radio"/>
on	ov	ob	nl	ni	ns	nsv	cl	csv	al	asv	nelv	nesv	olv	osv

Lampadario in rame e ottone.
(Fotografato e misurato con vetri 03-ACC-195-U)
Copper and brass chandelier.
(Photographed and measured with glass elements 03-ACC-195-U)



03-LAM-173-U

	NL	Wmax	Led	WLed	K°	V
E27	2	100	-	-	-	220 - 240

dimensioni
dimensions

L	H
182 71 ²¹ /32	130 51 ³ /16

finiture
finishes

<input type="radio"/>	<input type="radio"/>	<input type="radio"/>	<input type="radio"/>	<input type="radio"/>	<input type="radio"/>	<input type="radio"/>	<input type="radio"/>	<input type="radio"/>	<input type="radio"/>	<input type="radio"/>	<input type="radio"/>	<input type="radio"/>	<input type="radio"/>	<input type="radio"/>
on	ov	ob	nl	ni	ns	nsv	cl	csv	al	asv	nelv	nesv	olv	osv

Lampadario in legno patinato.
(Fotografato e misurato con paralumi 03-ACC-264-U)
Glazed wood chandelier.
(Photographed and measured with lampshades 03-ACC-264-U)



03-LAM-273-U

	NL	Wmax	Led	WLed	K°	V
E27	2	100	-	-	-	220 - 240

dimensioni
dimensions

L	H
182 71 ²¹ / ₃₂	130 51 ³ / ₁₆

finiture
finishes

<input type="radio"/>	<input type="radio"/>	<input type="radio"/>	<input type="radio"/>	<input type="radio"/>	<input type="radio"/>	<input type="radio"/>	<input type="radio"/>	<input type="radio"/>	<input type="radio"/>	<input type="radio"/>	<input type="radio"/>	<input type="radio"/>	<input type="radio"/>	<input type="radio"/>
on	ov	ob	nl	ni	ns	nsv	cl	csv	al	asv	nelv	nesv	olv	osv

Lampadario in legno patinato.
(Fotografato e misurato con paralumi 03-ACC-264-U)
Glazed wood chandelier.
(Photographed and measured with lampshades 03-ACC-264-U)

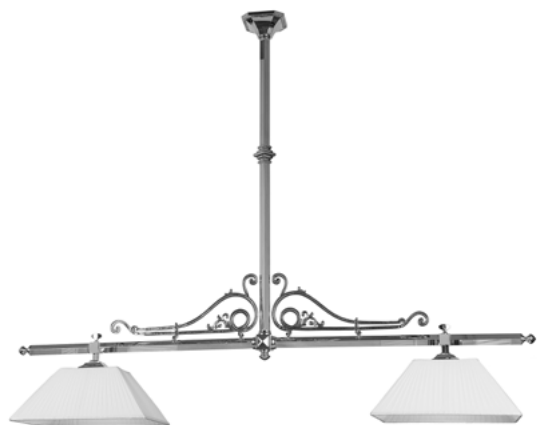

03-LAM-033-U

	NL	Wmax	Led	WLed	K°	V
E27	2	100	-	-	-	220 - 240

dimensioni
dimensions

L	H
174 68 ¹ / ₂	140 55 ¹ / ₈

finiture
finishes

<input type="radio"/>	<input checked="" type="radio"/>	<input type="radio"/>	<input type="radio"/>	<input type="radio"/>	<input type="radio"/>	<input type="radio"/>	<input type="radio"/>	<input type="radio"/>	<input type="radio"/>	<input type="radio"/>	<input type="radio"/>	<input type="radio"/>	<input type="radio"/>	<input type="radio"/>
on	ov	ob	nl	ni	ns	nsv	cl	csv	al	asv	nelv	nesv	olv	osv

Lampadario.
(Fotografato e misurato con paralumi 03-ACC-269-U)
Chandelier.
(Photographed and measured with lampshades 03-ACC-269-U)

03-LAM-093-U

	NL	Wmax	Led	WLed	K°	V
E27	2	100	-	-	-	220 - 240

dimensioni
dimensions

L	H
118 46 ²⁹ / ₆₄	113 44 ³¹ / ₆₄

finiture
finishes

<input type="radio"/>	<input type="radio"/>	<input type="radio"/>	<input type="radio"/>	<input type="radio"/>	<input type="radio"/>	<input type="radio"/>	<input type="radio"/>	<input type="radio"/>	<input type="radio"/>	<input type="radio"/>	<input type="radio"/>	<input type="radio"/>	<input type="radio"/>	<input type="radio"/>
on	ov	ob	nl	ni	ns	nsv	cl	csv	al	asv	nelv	nesv	olv	osv

Lampadario in ferro ruggine.
Rusty iron chandelier,







03-PIA-095-U

dimensioni
dimensions

finiture
finishes

	NL	Wmax	Led	WLed	K°	V
	-	-	✓	-	2700	220 - 240

ØB	Hmin	Hmax	RI
18 7 ³ / ₃₂	89 35 ³ / ₆₄	137 53 ¹⁵ / ₁₆	27,5 10 ⁵³ / ₆₄

<input type="radio"/>	<input type="radio"/>	<input type="radio"/>	<input type="radio"/>	<input type="radio"/>	<input type="radio"/>	<input type="radio"/>	<input type="radio"/>	<input type="radio"/>	<input type="radio"/>	<input type="radio"/>	<input type="radio"/>	<input type="radio"/>	<input type="radio"/>	<input type="radio"/>
on	ov	ob	nl	ni	ns	nsv	cl	csv	al	asv	nelv	nesv	olv	osv

Piantana allungabile.
Extendable floor lamp.

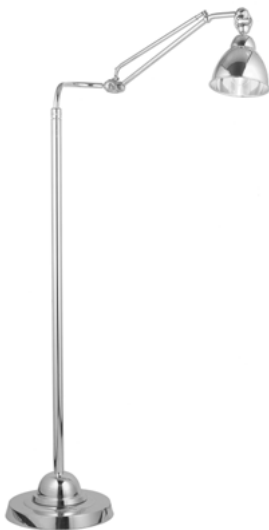

03-PIA-277-U

dimensioni
dimensions

finiture
finishes

	NL	Wmax	Led	WLed	K°	V
E27	1	60	-	-	-	220 - 240

ØB	Hmin	Hmax	RI
31 12 ¹³ / ₆₄	150 59 ¹ / ₁₆	195 76 ⁴⁹ / ₆₄	60 23 ⁵ / ₈

<input type="radio"/>	<input type="radio"/>	<input type="radio"/>	<input type="radio"/>	<input type="radio"/>	<input type="radio"/>	<input type="radio"/>	<input type="radio"/>	<input type="radio"/>	<input type="radio"/>	<input type="radio"/>	<input type="radio"/>	<input type="radio"/>	<input type="radio"/>	<input type="radio"/>
on	ov	ob	nl	ni	ns	nsv	cl	csv	al	asv	nelv	nesv	olv	osv

Piantana con snodi allungabile ed estensibile.
Extendable and extensible articulated floor lamp.



03-PIA-043-U

dimensioni
dimensions

finiture
finishes

	NL	Wmax	Led	WLed	K°	V
E27	1	100	-	-	-	220 - 240

ØB	Hmin	Hmax	RI
30 11 ¹³ / ₁₆	150 59 ¹ / ₁₆	195 76 ⁴⁹ / ₆₄	85 33 ¹⁵ / ₃₂

<input type="radio"/>	<input type="radio"/>	<input type="radio"/>	<input type="radio"/>	<input type="radio"/>	<input type="radio"/>	<input type="radio"/>	<input type="radio"/>	<input type="radio"/>	<input type="radio"/>	<input type="radio"/>	<input type="radio"/>	<input type="radio"/>	<input type="radio"/>	<input type="radio"/>
on	ov	ob	nl	ni	ns	nsv	cl	csv	al	asv	nelv	nesv	olv	osv

Piantana con snodi allungabile.
Extendable articulated floor lamp.



03-PIA-044-U

dimensioni
dimensions

finiture
finishes

	NL	Wmax	Led	WLed	K°	V
E27	1	100	-	-	-	220 - 240

ØB	Hmin	Hmax	RI
30 11 ¹³ / ₁₆	150 59 ¹ / ₁₆	195 76 ⁴⁹ / ₆₄	85 33 ¹⁵ / ₃₂

<input type="radio"/>	<input type="radio"/>	<input type="radio"/>	<input type="radio"/>	<input type="radio"/>	<input type="radio"/>	<input type="radio"/>	<input type="radio"/>	<input type="radio"/>	<input type="radio"/>	<input type="radio"/>	<input type="radio"/>	<input type="radio"/>	<input type="radio"/>	<input type="radio"/>
on	ov	ob	nl	ni	ns	nsv	cl	csv	al	asv	nelv	nesv	olv	osv

Piantana con snodi allungabile ed estensibile.
Extendable and extensible articulated floor lamp.

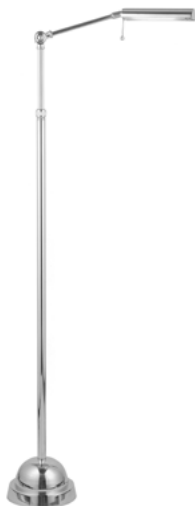

03-PIA-278-U

dimensioni
dimensions

finiture
finishes

	NL	Wmax	Led	WLed	K°	V
-	-	-	✓	-	2700	220 - 240

ØB	Hmin	Hmax	RI
16 6 ¹⁹ / ₆₄	100 39 ³ / ₈	150 59 ¹ / ₁₆	35 13 ²⁵ / ₃₂

<input type="radio"/>	<input type="radio"/>	<input type="radio"/>	<input type="radio"/>	<input type="radio"/>	<input type="radio"/>	<input type="radio"/>	<input type="radio"/>	<input type="radio"/>	<input type="radio"/>	<input type="radio"/>	<input type="radio"/>	<input type="radio"/>	<input type="radio"/>	<input type="radio"/>
on	ov	ob	nl	ni	ns	nsv	cl	csv	al	asv	nelv	nesv	olv	osv

Piantana con snodi allungabile.
Extendable articulated floor lamp.



03-PIA-049-U

dimensioni
dimensions

finiture
finishes

	NL	Wmax	Led	WLed	K°	V
E27	1	100	-	-	-	220 - 240

FxG	Hmin	Hmax	RI
20,5x20,5 8 ⁵ / ₆₄ x 8 ⁵ / ₆₄	150 59 ¹ / ₁₆	180 70 ⁵⁵ / ₆₄	35 13 ²⁵ / ₃₂

<input type="radio"/>	<input type="radio"/>	<input type="radio"/>	<input type="radio"/>	<input type="radio"/>	<input type="radio"/>	<input type="radio"/>	<input type="radio"/>	<input type="radio"/>	<input type="radio"/>	<input type="radio"/>	<input type="radio"/>	<input type="radio"/>	<input type="radio"/>	<input type="radio"/>
on	ov	ob	nl	ni	ns	nsv	cl	csv	al	asv	nelv	nesv	olv	osv

Piantana allungabile.
(Fotografata e misurata con paralume 03-ACC-272-U)
Extendable floor lamp.
(Photographed and measured with lampshade 03-ACC-272-U)



03-PIA-100-U

dimensioni
dimensions

finiture
finishes

	NL	Wmax	Led	WLed	K°	V
E27	1	100	-	-	-	220 - 240

ØB	Hmin	Hmax	RI
24 9 ²⁹ /64	120 47 ¹ /4	160 62 ⁶³ /64	50 19 ¹¹ /16

<input type="radio"/>	<input type="radio"/>	<input type="radio"/>	<input type="radio"/>	<input type="radio"/>	<input type="radio"/>	<input type="radio"/>	<input type="radio"/>	<input type="radio"/>	<input type="radio"/>	<input type="radio"/>	<input type="radio"/>	<input type="radio"/>	<input type="radio"/>	<input type="radio"/>
on	ov	ob	nl	ni	ns	nsv	cl	csv	al	asv	nelv	nesv	olv	osv

*Piantana allungabile ed estensibile.
(Fotografata e misurata con paralume 03-ACC-261-U)
Extendable and extensible floor lamp.
(Photographed and measured with lampshade 03-ACC-261-U)*



03-PIA-176-U

dimensioni
dimensions

finiture
finishes

	NL	Wmax	Led	WLed	K°	V
E27	1	100	-	-	-	220 - 240

ØB	Hmin	Hmax	RI
24 9 ²⁹ /64	120 47 ¹ /4	160 62 ⁶³ /64	50 19 ¹¹ /16

<input type="radio"/>	<input type="radio"/>	<input type="radio"/>	<input type="radio"/>	<input type="radio"/>	<input type="radio"/>	<input type="radio"/>	<input type="radio"/>	<input type="radio"/>	<input type="radio"/>	<input type="radio"/>	<input type="radio"/>	<input type="radio"/>	<input type="radio"/>	<input type="radio"/>
on	ov	ob	nl	ni	ns	nsv	cl	csv	al	asv	nelv	nesv	olv	osv

*Piantana allungabile ed estensibile.
(Fotografata e misurata con paralume 03-ACC-261-U)
Extendable and extensible floor lamp.
(Photographed and measured with lampshade 03-ACC-261-U)*



03-PIA-163-U

dimensioni
dimensions

finiture
finishes

	NL	Wmax	Led	WLed	K°	V
E27	1	100	-	-	-	220 - 240

ØB	Hmin	Hmax	RI
28 11 ¹ /32	149 58 ²¹ /32	212 83 ¹⁵ /32	55 21 ²¹ /32

<input type="radio"/>	<input type="radio"/>	<input type="radio"/>	<input type="radio"/>	<input type="radio"/>	<input type="radio"/>	<input type="radio"/>	<input type="radio"/>	<input type="radio"/>	<input type="radio"/>	<input type="radio"/>	<input type="radio"/>	<input type="radio"/>	<input type="radio"/>	<input type="radio"/>
on	ov	ob	nl	ni	ns	nsv	cl	csv	al	asv	nelv	nesv	olv	osv

*Piantana allungabile.
(Fotografata e misurata con paralume 03-ACC-261-U)
Extendable floor lamp.
(Photographed and measured with lampshade 03-ACC-261-U)*



03-PIA-037-U

dimensioni
dimensions

finiture
finishes

	NL	Wmax	Led	WLed	K°	V
E27	1	100	-	-	-	220 - 240

ØB	Hmin	Hmax	RI
58 22 ⁵³ /64	142 55 ²⁹ /32	169 66 ¹⁷ /32	57 22 ⁷ /16

<input checked="" type="radio"/>	<input type="radio"/>	<input type="radio"/>	<input type="radio"/>	<input type="radio"/>	<input type="radio"/>	<input type="radio"/>	<input type="radio"/>	<input type="radio"/>	<input type="radio"/>	<input type="radio"/>	<input type="radio"/>	<input type="radio"/>	<input type="radio"/>	<input type="radio"/>	<input type="radio"/>
on	ov	ob	nl	ni	ns	nsv	cl	csv	al	asv	nelv	nesv	olv	osv	

Piantana allungabile in ferro nero e ottone.
(Fotografata e misurata con paralume 03-ACC-261-U)
Extendable black iron and brass floor lamp.
(Photographed and measured with lampshade 03-ACC-261-U)



03-PIA-036-U

dimensioni
dimensions

finiture
finishes

	NL	Wmax	Led	WLed	K°	V
E27	1	100	-	-	-	220 - 240

ØB	Hmin	Hmax	RI
58 22 ⁵³ /64	142 55 ²⁹ /32	169 66 ¹⁷ /32	57 22 ⁷ /16

<input type="radio"/>	<input type="radio"/>	<input type="radio"/>	<input type="radio"/>	<input type="radio"/>	<input type="radio"/>	<input type="radio"/>	<input type="radio"/>	<input type="radio"/>	<input type="radio"/>	<input type="radio"/>	<input type="radio"/>	<input type="radio"/>	<input type="radio"/>	<input type="radio"/>	<input type="radio"/>
on	ov	ob	nl	ni	ns	nsv	cl	csv	al	asv	nelv	nesv	olv	osv	

Piantana allungabile in ferro spazzolato e ottone.
(Fotografata e misurata con paralume 03-ACC-261-U)
Extendable brushed iron and brass floor lamp.
(Photographed and measured with lampshade 03-ACC-261-U)



03-LDT-166-U

	NL	Wmax	Led	WLed	K°	V
E14	1	40	-	-	-	220 - 240

dimensioni
dimensions

FxG	H	RI
12x12 4 ²³ /32 x 4 ²³ /32	43,5 17 ¹ /8	23 9 ¹ /16

finiture
finishes

○ on	○ ov	○ ob	○ nl	○ ni	○ ns	○ nsv	○ cl	○ csv	○ al	○ asv	○ nelv	○ nesv	○ olv	○ osv
------	------	------	------	------	------	-------	------	-------	------	-------	--------	--------	-------	-------

Lampada da tavolo.
(Fotografata e misurata con paralume 03-ACC-262-U)
Table lamp.
(Photographed and measured with lampshade 03-ACC-262-U)



03-LDT-063-U

	NL	Wmax	Led	WLed	K°	V
E27	1	40	-	-	-	220 - 240

dimensioni
dimensions

FxG	Hmin	Hmax
16x16 6 ¹⁹ /64 x 6 ¹⁹ /64	55,5 21 ²⁷ /32	72 28 ¹¹ /32

finiture
finishes

○ on	○ ov	○ ob	○ nl	○ ni	○ ns	○ nsv	○ cl	○ csv	○ al	○ asv	○ nelv	○ nesv	○ olv	○ osv
------	------	------	------	------	------	-------	------	-------	------	-------	--------	--------	-------	-------

Lampada da tavolo allungabile.
(Fotografata e misurata con paralume 03-ACC-263-U)
Extendable table lamp
(Photographed and measured with lampshade 03-ACC-263-U)



03-LDT-039-U

	NL	Wmax	Led	WLed	K°	V
E27	1	60	-	-	-	220 - 240

dimensioni
dimensions

FxG	H	RxS
18x12 7 ³ /32 x 4 ²³ /32	70 27 ⁹ /16	35x18 13 ²⁵ /32 x 7 ³ /32

finiture
finishes

○ on	○ ov	○ ob	○ nl	○ ni	○ ns	○ nsv	○ cl	○ csv	○ al	○ asv	○ nelv	○ nesv	○ olv	○ osv
------	------	------	------	------	------	-------	------	-------	------	-------	--------	--------	-------	-------

Lampada da tavolo.
(Fotografata e misurata con paralume 03-ACC-270-U)
Table lamp.
(Photographed and measured with lampshade 03-ACC-270-U)



03-LDT-028-U

NL Wmax Led WLed K° V

E27 1 40 - - - 220 - 240

dimensioni
dimensions

FxG Hmin Hmax
10,5x10,5 | 4⁹/64 x 4⁹/64 59 | 23¹⁵/64 71 | 27⁶¹/64

finiture
finishes

on ov ob nl ni ns nsv cl csv al asv nelv nesv olv osv

Lampada da tavolo.
(Fotografata e misurata con paralume 03-ACC-263-U)
Table lamp.
(Photographed and measured with lampshade 03-ACC-263-U)



03-LDT-276-U

NL Wmax Led WLed K° V

E27 1 40 - - - 220 - 240

dimensioni
dimensions

ØB H ØI
12 | 4²³/32 23 | 9¹/16 19 | 7³¹/64

finiture
finishes

on ov ob nl ni ns nsv cl csv al asv nelv nesv olv osv

Lampada da tavolo.
(Fotografata e misurata con paralume 03-ACC-285-U)
Table lamp.
(Photographed and measured with lampshade 03-ACC-285-U)



03-LDT-281-U

NL Wmax Led WLed K° V

E27 1 60 - - - 220 - 240

dimensioni
dimensions

ØB H RI
17,5 | 7³/32 67 | 26³/8 40 | 15³/4

finiture
finishes

on ov ob nl ni ns nsv cl csv al asv nelv nesv olv osv

Lampada da tavolo con snodi.
Articulated table lamp.



		NL	Wmax	Led	WLed	K°	V
03-LDT-282-U	E14	1	40	-	-	-	220 - 240
<i>dimensioni</i> <i>dimensions</i>	ØB		H		RI		
	15,5 6 ¹⁹ / ₆₄		71,5 28 ¹¹ / ₃₂		19 7 ³¹ / ₆₄		
<i>finiture</i> <i>finishes</i>	<input type="radio"/>	<input type="radio"/>	<input type="radio"/>	<input type="radio"/>	<input type="radio"/>	<input type="radio"/>	<input type="radio"/>
	on	ov	ob	nl	ni	ns	nsv
							cl
							csv
							al
							asv
							nelv
							nesv
							olv
							osv

Lampada da tavolo con ventola in ottone.
Table lamp with brass shade.





03-LDE-068-U

	NL	Wmax	Led	WLed	K°	V
E27	1	60	-	-	-	220 - 240

dimensioni
dimensions

ØB	H	Ag
9 3 ³⁵ /64	13 5 ¹ /8	44 17 ²¹ /64

finiture
finishes

<input type="radio"/>	<input type="radio"/>	<input type="radio"/>	<input type="radio"/>	<input type="radio"/>	<input type="radio"/>	<input type="radio"/>	<input type="radio"/>	<input type="radio"/>	<input type="radio"/>	<input type="radio"/>	<input type="radio"/>	<input type="radio"/>	<input type="radio"/>	<input type="radio"/>
on	ov	ob	nl	ni	ns	nsv	cl	csv	al	asv	nelv	nesv	olv	osv

Applique a piombaggine con piatto smaltato.
Plumbago (graphite) wall light with enameled dish.

03-LDE-139-U

	NL	Wmax	Led	WLed	K°	V
E14	1	40	-	-	-	220 - 240

dimensioni
dimensions

FxG	H	RI
12x12 4 ²³ /32 x 4 ²³ /32	43,5 17 ¹ /8	23 9 ¹ /16

finiture
finishes

<input type="radio"/>	<input type="radio"/>	<input type="radio"/>	<input type="radio"/>	<input type="radio"/>	<input type="radio"/>	<input type="radio"/>	<input type="radio"/>	<input type="radio"/>	<input type="radio"/>	<input type="radio"/>	<input type="radio"/>	<input type="radio"/>	<input type="radio"/>	<input type="radio"/>
on	ov	ob	nl	ni	ns	nsv	cl	csv	al	asv	nelv	nesv	olv	osv

Applique con piatto smaltato.
Wall light with enameled dish.

03-LDE-140-U

	NL	Wmax	Led	WLed	K°	V
E27	1	40	-	-	-	220 - 240



dimensioni
dimensions



FxG	Hmin	Hmax
16x16 6 ¹⁹ /64 x 6 ¹⁹ /64	55,5 21 ²⁷ /32	72 28 ¹¹ /32

finiture
finishes

<input type="radio"/>	<input type="radio"/>	<input type="radio"/>	<input type="radio"/>	<input type="radio"/>	<input type="radio"/>	<input type="radio"/>	<input type="radio"/>	<input type="radio"/>	<input type="radio"/>	<input type="radio"/>	<input type="radio"/>	<input type="radio"/>	<input type="radio"/>	<input type="radio"/>
on	ov	ob	nl	ni	ns	nsv	cl	csv	al	asv	nelv	nesv	olv	osv

Applique a piombaggine con piatto smaltato.
Plumbago (graphite) wall light with enameled dish.

		NL	Wmax	Led	WLed	K°	V
03-LDE-098-U	E27	1	40	-	-	-	220 - 240
<i>dimensioni</i> <i>dimensions</i>	FxG		Hmin		Hmax		
	10,5x10,5 4 ⁹ /64 x 4 ⁹ /64		59 23 ¹⁵ /64		71 27 ⁶¹ /64		
<i>finiture</i> <i>finishes</i>							
	<i>Lampione a piombaggine.</i> <i>Table lamp.</i>						

		NL	Wmax	Led	WLed	K°	V
03-LDE-062-U	E27	1	40	-	-	-	220 - 240
<i>dimensioni</i> <i>dimensions</i>	ØB			H		ØI	
	12 4 ²³ /32			23 9 ¹ /16		19 7 ³¹ /64	
<i>finiture</i> <i>finishes</i>							
	<i>Piantana in ferro.</i> <i>Iron floor lamp.</i>						



03-ACC-258-U

dimensioni
dimensions

Øinf	Øsup	d
12,5 4 ⁵⁹ /64	8 3 ⁵ /32	12 4 ²³ /32

Paralume a pieghe in tessuto beige. Attacco alto mignon al pari.
Pleated beige fabric lampshade. Level high mignon socket



03-ACC-257-U

dimensioni
dimensions

Øinf	Øsup	d
12,5 4 ⁵⁹ /64	8 3 ⁵ /32	12 4 ²³ /32

Paralume a pieghe in tessuto beige. Attacco basso mignon al pari.
Pleated beige fabric lampshade. Level low mignon socket.



03-ACC-285-U

dimensioni
dimensions

Øinf	Øsup	d
15 5 ²⁹ /32	8 3 ⁵ /32	10 3 ¹⁵ /16

Paralume a pieghe in tessuto beige. Attacco alto edison al pari.
Pleated beige fabric lampshade. Level high edison socket.



03-ACC-255-U

dimensioni
dimensions

Øinf	Øsup	d
15 5 ²⁹ /32	9 3 ³⁵ /64	11 4 ²¹ /64

Paralume a pieghe in tessuto beige. Attacco basso mignon. Rientro 2 cm.
Pleated beige fabric lampshade. Low mignon socket. Recess 2 cm.



03-ACC-256-U

dimensioni
dimensions

Øinf	Øsup	d
15 5 ²⁹ / ₃₂	9 3 ³⁵ / ₆₄	14 5 ³³ / ₆₄

Paralume a pieghe in tessuto beige. Attacco basso mignon. Rientro 2 cm.
Pleated beige fabric lampshade. Low mignon socket. Recess 2 cm.



03-ACC-262-U

dimensioni
dimensions

Øinf	Øsup	d
15,5 6 ⁷ / ₆₄	8,5 3 ¹¹ / ₃₂	11,5 4 ¹⁷ / ₃₂

Paralume a pieghe in tessuto beige. Attacco alto mignon. Rientro 1,5 cm.
Pleated beige fabric lampshade. High mignon socket. Recess 1.5 cm.



03-ACC-260-U

dimensioni
dimensions

Øinf	Øsup	d
17 6 ¹¹ / ₁₆	10 3 ¹⁵ / ₁₆	15 5 ²⁹ / ₃₂

Paralume a pieghe in tessuto beige. Attacco alto edison al pari
Pleated beige fabric lampshade. Level high edison socket.



03-ACC-266-U

dimensioni
dimensions

Øinf	Øsup	d
18,5 7 ⁹ / ₃₂	10 3 ¹⁵ / ₁₆	15 5 ²⁹ / ₃₂

Paralume a pieghe in tessuto beige. Attacco alto edison al pari
Pleated beige fabric lampshade. Level high edison socket.

03-ACC-253-U



dimensioni
dimensions

Øinf	Øsup	d
20 7 ⁷ / ₈	12 4 ²³ / ₃₂	13 5 ¹ / ₈

Paralume a pieghe in tessuto beige. Attacco basso mignon. Rientro 2 cm.
Pleated beige fabric lampshade. Low mignon socket. Recess 2 cm.

03-ACC-254-U



dimensioni
dimensions

Øinf	Øsup	d
23 9 ¹ / ₁₆	12 4 ²³ / ₃₂	15 5 ²⁹ / ₃₂

Paralume a pieghe in tessuto beige. Attacco basso mignon. Rientro 2 cm.
Pleated beige fabric lampshade. Low mignon socket. Recess 2 cm.

03-ACC-259-U



dimensioni
dimensions

Øinf	Øsup	d
23,5 9 ¹ / ₄	12,5 4 ⁵⁹ / ₆₄	15,5 6 ⁷ / ₆₄

Paralume a pieghe in tessuto beige. Attacco basso edison. Rientro 2 cm.
Pleated beige fabric lampshade. Low edison socket. Recess 2 cm.

03-ACC-268-U



dimensioni
dimensions

Øinf	Øsup	d
40 15 ³ / ₄	20 7 ⁷ / ₈	25 9 ²⁷ / ₃₂

Paralume a pieghe in tessuto beige. Attacco alto edison al pari.
Pleated beige fabric lampshade. Level high mignon socket.



03-ACC-261-U

dimensioni
dimensions

Øinf	Øsup	d
45,5 17 ²⁹ /32	26 10 ¹⁵ /64	24,5 9 ⁴¹ /64

Paralume a pieghe in tessuto beige. Attacco basso edison. Rientro 2 cm.
Pleated beige fabric lampshade. Low edison socket. Recess 2 cm.



03-ACC-271-U

dimensioni
dimensions

Øinf	H
46,5 18 ⁵ /16	21 8 ¹⁷ /64

Paralume a pieghe in tessuto beige. Attacco alto edison al pari.
Pleated beige fabric lampshade. Level high edison socket.



03-ACC-264-U

dimensioni
dimensions

Øinf	Øsup	d
48,5 19 ³ /32	26 10 ¹⁵ /64	26 10 ¹⁵ /64

Paralume a pieghe in tessuto beige. Attacco alto edison al pari.
Pleated beige fabric lampshade. Level high edison socket.



03-ACC-288-U

dimensioni
dimensions

PxQinf	PxQsup	d
14x14 5 ³³ /64 x 5 ³³ /64	9x9 3 ³⁵ /64 x 3 ³⁵ /64	17 6 ¹¹ /16

Paralume a pieghe in tessuto beige. Attacco mignon basso. Rientro 2,5 cm.
Pleated beige fabric lampshade. Low mignon socket. Recess 2,5 cm.



03-ACC-175-U

dimensioni
dimensions

PxQinf	PxQsup	d
14x14 $5^{33}/64 \times 5^{33}/64$	10,5x10,5 $4^9/64 \times 4^9/64$	16 $6^{19}/64$

Paralume a pieghe in tessuto beige. Attacco basso mignon. Rientro 2 cm.
Pleated beige fabric lampshade. Low mignon socket. Recess 2 cm.



03-ACC-263-U

dimensioni
dimensions

PxQinf	PxQsup	d
20x20 $7^7/8 \times 7^7/8$	10,5x10,5 $4^9/64 \times 4^9/64$	20 $7^7/8$

Paralume a pieghe in tessuto beige. Attacco basso edison. Rientro 3 cm.
Pleated beige fabric lampshade. Low edison socket. Recess 3 cm.



03-ACC-272-U

dimensioni
dimensions

PxQinf	PxQsup	d
35x35 $13^{26}/32 \times 13^{26}/32$	21x21 $8^{17}/64 \times 8^{17}/64$	35 $13^{26}/32$

Paralume a pieghe in tessuto beige. Attacco basso edison. Rientro 3 cm.
Pleated beige fabric lampshade. Low edison socket. Recess 3 cm.



03-ACC-269-U

dimensioni
dimensions

PxQinf	PxQsup	d
44x44 $17^{21}/64 \times 17^{21}/64$	20x20 $7^7/8 \times 7^7/8$	25 $9^{27}/32$

Paralume a pieghe in tessuto beige. Attacco alto edison al pari.
Pleated beige fabric lampshade. Level high mignon socket.



03-ACC-270-U

dimensioni
dimensions

PxQinf	PxQsup	H
35x18 13 ²⁵ / ₃₂ x 7 ³ / ₃₂	35x18 13 ²⁵ / ₃₂ x 7 ³ / ₃₂	25 9 ²⁷ / ₃₂

Paralume a pieghe in tessuto beige. Attacco basso edison. Rientro 3 cm.
Pleated beige fabric lampshade. Low edison socket. Recess 3 cm.



03-ACC-234-U

dimensioni
dimensions

Øinf	Øsup	d
21 8 ¹⁷ / ₆₄	17 6 ¹¹ / ₁₆	10,5 4 ⁹ / ₆₄

finiture
finishes



Ventola in lamiera per applique 03-APP-018-U.
Sheet metal shade for wall light 03-APP-018-U.



03-ACC-236-U

dimensioni
dimensions

Øinf	Øsup	d
21 8 ¹⁷ / ₆₄	16,5 6 ¹ / ₂	12,5 4 ⁵⁹ / ₆₄

finiture
finishes

Paralume in pergamena per applique 03-APP-246-U
Parchment lampshade for wall light 03-APP-246-U



03-ACC-174-U

dimensioni
dimensions

Øinf	Øsup	d
25 9 ²⁷ / ₃₂	10 3 ¹⁵ / ₁₆	14 5 ³³ / ₆₄

finiture
finishes



Ventola in lamiera per applique 03-APP-216-U.
Sheet metal shade for wall light 03-APP-216-U.



03-ACC-196-U

dimensioni
dimensions

Øinf	Øsup	d
25 9 ²⁷ / ₃₂	9,5 3 ⁴⁷ / ₆₄	14,5 5 ⁴⁵ / ₆₄

finiture
finishes

<input type="radio"/>	<input type="radio"/>	<input type="radio"/>	<input type="radio"/>	<input type="radio"/>	<input type="radio"/>	<input type="radio"/>	<input type="radio"/>	<input type="radio"/>	<input type="radio"/>	<input type="radio"/>	<input type="radio"/>	<input type="radio"/>	<input type="radio"/>	<input type="radio"/>
on	ov	ob	nl	ni	ns	nsv	cl	csv	al	asv	nelv	nesv	olv	osv

Ventola in lamiera per applique 03-APP-029-U.
Sheet metal shade for wall light 03-APP-029-U.



03-ACC-287-U

dimensioni
dimensions

Øinf	Øsup	d
15,5 6 ⁷ / ₆₄	8,5 3 ¹¹ / ₃₂	11,5 4 ¹⁷ / ₃₂

finiture
finishes

<input type="radio"/>	<input type="radio"/>	<input type="radio"/>	<input type="radio"/>	<input type="radio"/>	<input type="radio"/>	<input type="radio"/>	<input type="radio"/>	<input type="radio"/>	<input type="radio"/>	<input type="radio"/>	<input type="radio"/>	<input type="radio"/>	<input type="radio"/>	<input type="radio"/>
on	ov	ob	nl	ni	ns	nsv	cl	csv	al	asv	nelv	nesv	olv	osv

Ventola in lamiera per applique 03-APP-289-U.
Sheet metal shade for wall light 03-APP-289-U.



03-ACC-232-U

dimensioni
dimensions

PxQinf	PxQsup	d
19,5x19,5 7 ⁴³ / ₆₄ x 7 ⁴³ / ₆₄	13x13 5 ¹ / ₈ x 5 ¹ / ₈	14 5 ³³ / ₆₄

finiture
finishes

<input type="radio"/>	<input type="radio"/>	<input type="radio"/>	<input type="radio"/>	<input type="radio"/>	<input type="radio"/>	<input type="radio"/>	<input type="radio"/>	<input type="radio"/>	<input type="radio"/>	<input type="radio"/>	<input type="radio"/>	<input type="radio"/>	<input type="radio"/>	<input type="radio"/>
on	ov	ob	nl	ni	ns	nsv	cl	csv	al	asv	nelv	nesv	olv	osv

Ventola ottagonale per applique 03-APP-211-U
Octagonal shade for wall light 03-APP-211-U.



dimensioni
dimensions

L	H
03-ACC-065-S 25 9 ²⁷ / ₃₂	2,5 0 ⁶³ / ₆₄
03-ACC-065-M 35 13 ²⁵ / ₃₂	
03-ACC-065-L 50 19 ¹¹ / ₁₈	5,5 2 ¹¹ / ₆₄

Piatto in alluminio smaltato.
Enameled aluminum dish.



03-ACC-157-U

dimensioni
dimensions

L	H
37 14 ⁹ / ₁₆	13,5 5 ³³ / ₆₄

Ventola in rame.
Copper shade.



03-ACC-141-U

dimensioni
dimensions

Øinf	Øsup	d
20,5 8 ⁵ / ₆₄	6 2 ²³ / ₆₄	7,5 2 ⁶¹ / ₆₄

finiture
finishes



Ventola in lamiera per applique 03-APP-007/010/134/248/229-U.
Sheet metal shade for wall light 03-APP-007/010/134/248/229-U.



03-ACC-120-U

dimensioni
dimensions

ØI	H	ØZ
17,5 6 ⁵⁷ / ₆₄	7 2 ³ / ₄	5,5 2 ¹¹ / ₆₄

Vetro opaline per applique 03-APP-009/012/133/184/205/228-U.
Opaline glass for wall light 03-APP-009/012/133/184/205/228-U.



03-ACC-195-U

dimensioni
dimensions

ØI	H
29 11 ²⁷ / ₆₄	10,5 4 ⁹ / ₆₄

Vetro opaline per applique 03-APP-215-U/03-LAM-283/284-U.
Opaline glass for wall light 03-APP-215-U/03-LAM-283/284-U.



03-ACC-064-S

dimensioni
dimensions

ØI	H	ØZ
14 5 ³³ / ₆₄	14 5 ³³ / ₆₄	7,8 3 ⁵ / ₆₄

Vetro opaline per art.
03-APP-071/189/207/213-U
03-PLA-237/238/239/240/241-U
Opaline glass for
03-APP-071/189/207/213-U
03-PLA-237/238/239/240/241-U



03-ACC-064-M

dimensioni
dimensions

ØI	H	ØZ
16 6 ¹⁹ / ₆₄	16 6 ¹⁹ / ₆₄	8 3 ⁵ / ₃₂

Vetro opaline per applique 03-APP-182-U.
Opaline glass for wall light 03-APP-182-U.



03-ACC-064-L

dimensioni
dimensions

ØI	H	ØZ
20 7 ⁷ / ₈	20 7 ⁷ / ₈	10 3 ¹⁵ / ₁₆

Vetro opaline per lampadario 03-LAM-161-U.
Opaline glass for chandelier 03-LAM-161-U.



03-ACC-247-U

dimensioni
dimensions

ØI	H	ØZ
10 3 ¹⁵ / ₁₆	10 3 ¹⁵ / ₁₆	6 2 ²³ / ₆₄

Vetro opaline per applique 03-APP-047-U.
Opaline glass for wall light 03-APP-047-U.



03-ACC-198-U

dimensioni
dimensions

ØI	H	ØZ
10,5 4 ⁹ / ₆₄	13,5 5 ⁵ / ₁₆	8 3 ⁵ / ₃₂

Vetro trasparente per applique 03-APP-030-U.
Transparent glass for wall light 03-APP-030-U.



03-ACC-128-U

dimensioni
dimensions

ØI	H	ØZ
14 5 ³³ / ₆₄	13,5 5 ⁵ / ₁₆	7,8 3 ⁵ / ₆₄

Vetro sabbato e molato per art.
03-APP-214/183/190/208/072/032/104/105-U
03-PLA 144/145/146/147/148-U.
Sandblasted and beveled glass for
03-APP-214/183/190/208/072/032/104/105-U
03-PLA-144/145/146/147/148-U.



03-ACC-170-U

dimensioni
dimensions

ØI	H	ØZ
12,5 4 ⁵⁹ / ₆₄	11 4 ²¹ / ₆₄	6 2 ²³ / ₆₄

Vetro sabbato e molato per applique
03-APP-008/011/013/014/185/132/206/227-U.
Sandblasted and beveled glass for wall light
03-APP-008/011/013/014/185/132/206/227-U.



03-ACC-230-U

dimensioni
dimensions

ØI	H
11 4 ²¹ / ₆₄	5 1 ³¹ / ₃₂

Vetro sabbato e molato per plafoniere 03-PLA-082/083-U.
Sandblasted and beveled glass for ceiling lights 03-PLA-082/083-U.

03-ACC-127-S



dimensioni
dimensions

ØI	H
18,4 7 ¹ / ₄	6 2 ²³ / ₆₄

Vetro sabbato per plafoniere :
03-PLA-041/042/073/074-S.
Sandblasted glass for ceiling lights:
03-PLA-041/042/073/074-S.

03-ACC-127-L



dimensioni
dimensions

ØI	H
27,8 10 ¹⁵ / ₁₆	9 3 ³⁵ / ₆₄

Vetro sabbato per plafoniere :
03-PLA-041/042/073/074-L.
Sandblasted glass for ceiling lights:
03-PLA-041/042/073/074-L.

03-ACC-233-U



dimensioni
dimensions

ØI	H	ØZ
18 7 ³ / ₃₂	6,5 2 ⁹ / ₁₆	15 5 ²⁹ / ₃₂

Vetro sabbato e molato per plafoniere:
03-PLA-085/086/087/200/201/202/221/222/223-U.
Sandblasted and beveled glass for ceiling lights:
03-PLA-085/086/087/200/201/202/221/222/223-U.

03-ACC-143-U



dimensioni
dimensions

ØI	H	ØZ
17,5 6 ⁵⁷ / ₆₄	12,5 4 ⁵⁹ / ₆₄	6 2 ²³ / ₆₄

Vetro sabbato e molato per plafoniere:
03-PLA-019/020/021/022/023/107/108/109/110/111-U.
Sandblasted and beveled glass for ceiling lights:
03-PLA-019/020/021/022/023/107/108/109/110/111-U.



03-ACC-038-S

dimensioni
dimensions

ØI	H	ØZ
16,5 6 1/2	11 4 21/64	14,5 5 45/64

Vetro sabbato e molato per plafoniere:
03-PLA-051/052/053/054/055-S.
Sandblasted and beveled glass for ceiling lights:
03-PLA-051/052/053/054/055-S



03-ACC-038-L

dimensioni
dimensions

ØI	H	ØZ
21 8 17/64	14 5 33/64	19,5 7 43/64

Vetro sabbato e molato per plafoniere:
03-PLA-051/052/053/054/055-L.
Sandblasted and beveled glass for ceiling lights:
03-PLA-051/052/053/054/055-L.



03-ACC-159-S

dimensioni
dimensions

ØB	H
4 1 37/64	5 1 31/32

○ ○ ○ ○ ○ ○ ○ ○ ○ ○ ○ ○ ○ ○ ○ ○
on ov ob nl ni ns nsv cl csv al asv nelv nesv olv osv

Borchia con foro diametro 10 mm.
Cover with 10 mm diameter hole.



03-ACC-159-M

dimensioni
dimensions

ØB	H
5,7 2 1/4	5 1 31/32

○ ○ ○ ○ ○ ○ ○ ○ ○ ○ ○ ○ ○ ○ ○ ○
on ov ob nl ni ns nsv cl csv al asv nelv nesv olv osv

Borchia con foro diametro 10 mm.
Cover with 10 mm diameter hole.



03-ACC-159-L

dimensioni
dimensions

ØB H
6,8 | 2⁴³/64 7 | 2³/4

○ ○ ○ ○ ○ ○ ○ ○ ○ ○ ○ ○ ○ ○ ○ ○
on ov ob nl ni ns nsv cl csv al asv nelv nesv olv osv

Borchia con foro diametro 10 mm.
Cover with 10 mm diameter hole.



03-ACC-231-U

dimensioni
dimensions

ØB H
6,7 | 2⁴¹/64 3 | 1³/16

○ ○ ○ ○ ○ ○ ○ ○ ○ ○ ○ ○ ○ ○ ○ ○
on ov ob nl ni ns nsv cl csv al asv nelv nesv olv osv

Borchia con foro diametro 10 mm.
Cover with 10 mm diameter hole.



03-ACC-035-U

dimensioni
dimensions

ØB H
7,3 | 2⁷/8 5 | 1³¹/32

○ ○ ○ ○ ○ ○ ○ ○ ○ ○ ○ ○ ○ ○ ○ ○
on ov ob nl ni ns nsv cl csv al asv nelv nesv olv osv

Borchia con foro diametro 10 mm.
Cover with 10 mm diameter hole.



03-ACC-171-U

dimensioni
dimensions

ØB H
7 | 2³/4 3,7 | 1²⁹/64

○ ○ ○ ○ ○ ○ ○ ○ ○ ○ ○ ○ ○ ○ ○ ○
on ov ob nl ni ns nsv cl csv al asv nelv nesv olv osv

Borchia con foro diametro 10 mm.
Cover with 10 mm diameter hole.



03-ACC-102-U

dimensioni
dimensions

ØB H
7 | 2³/₄ 4 | 1³⁷/₆₄

○ ○ ○ ○ ○ ○ ○ ○ ○ ○ ○ ○ ○ ○ ○ ○
on ov ob nl ni ns nsv cl csv al asv nelv nesv olv osv

Borchia con foro diametro 10 mm.
Cover with 10 mm diameter hole.



03-ACC-066-U

dimensioni
dimensions

ØB H
8 | 3⁵/₃₂ 5,5 | 2¹¹/₆₄

○ ○ ○ ○ ○ ○ ○ ○ ○ ○ ○ ○ ○ ○ ○ ○
on ov ob nl ni ns nsv cl csv al asv nelv nesv olv osv

Borchia con foro diametro 10 mm.
Cover with 10 mm diameter hole.



03-ACC-194-U

dimensioni
dimensions

ØB H
11 | 4²¹/₆₄ 5 | 1³¹/₃₂

○ ○ ○ ○ ○ ○ ○ ○ ○ ○ ○ ○ ○ ○ ○ ○
on ov ob nl ni ns nsv cl csv al asv nelv nesv olv osv

Borchia con foro diametro 10 mm.
Cover with 10 mm diameter hole.



03-ACC-125-U

dimensioni
dimensions

ØB H
9,5 | 3⁴⁷/₆₄ 6,5 | 2⁹/₁₆

○ ○ ○ ○ ○ ○ ○ ○ ○ ○ ○ ○ ○ ○ ○ ○
on ov ob nl ni ns nsv cl csv al asv nelv nesv olv osv

Borchia con foro diametro 10 mm.
Cover with 10 mm diameter hole.

03-ACC-197-U



dimensioni
dimensions

ØB H
11 | 4²¹/₆₄ 5 | 1³¹/₃₂

○ ○ ○ ○ ○ ○ ○ ○ ○ ○ ○ ○ ○ ○ ○ ○
on ov ob nl ni ns nsv cl csv al asv nelv nesv olv osv

Borchia con foro diametro 10 mm.
Cover with 10 mm diameter hole.

03-ACC-267-U



dimensioni
dimensions

ØB H
16,5 | 6¹/₂ 8 | 3⁵/₃₂

○ ○ ○ ○ ○ ○ ○ ○ ○ ○ ○ ○ ○ ○ ○ ○
on ov ob nl ni ns nsv cl csv al asv nelv nesv olv osv

Borchia per asta diametro 20 mm con fissaggio a soffitto.
Cover body for 20 mm diameter pole with ceiling fastening.

03-ACC-069-U



dimensioni
dimensions

ØB H
14 | 5³³/₆₄ 6,5 | 2⁹/₁₆

○ ○ ○ ○ ○ ○ ○ ○ ○ ○ ○ ○ ○ ○ ○ ○
on ov ob nl ni ns nsv cl csv al asv nelv nesv olv osv

Borchia con foro diametro 10 mm.
Cover with 10 mm diameter hole.

03-ACC-158-U



dimensioni
dimensions

ØB H
14 | 5³³/₆₄ 6,8 | 2⁴³/₆₄

○ ○ ○ ○ ○ ○ ○ ○ ○ ○ ○ ○ ○ ○ ○ ○
on ov ob nl ni ns nsv cl csv al asv nelv nesv olv osv

Borchia con foro diametro 10 mm.
Cover with 10 mm diameter hole.

03-ACC-199-U



dimensioni
dimensions

ØB H
15,3 | 6¹/₃₂ 8 | 3⁵/₃₂

○ ○ ○ ○ ○ ○ ○ ○ ○ ○ ○ ○ ○ ○ ○ ○
on ov ob nl ni ns nsv cl csv al asv nelv nesv olv osv

Borchia con foro diametro 20 mm.
Cover with 20 mm diameter hole.

03-ACC-250-U



dimensioni
dimensions

ØB H
15 | 5²⁹/₃₂ 8 | 3⁵/₃₂

○ ○ ○ ○ ○ ○ ○ ○ ○ ○ ○ ○ ○ ○ ○ ○
on ov ob nl ni ns nsv cl csv al asv nelv nesv olv osv

Borchia per asta diametro 20 mm
Cover body for 20 mm diameter pole.

03-ACC-034-U



dimensioni
dimensions

ØB H
16,5 | 6¹/₂ 8 | 3⁵/₃₂

○ ○ ○ ○ ○ ○ ○ ○ ○ ○ ○ ○ ○ ○ ○ ○
on ov ob nl ni ns nsv cl csv al asv nelv nesv olv osv

Borchia per asta diametro 20 mm
Cover body for 20 mm diameter pole.

03-ACC-101-U



dimensioni
dimensions

ØB H
17 | 6¹¹/₁₆ 18,5 | 7⁹/₃₂

○ ○ ○ ○ ○ ○ ○ ○ ○ ○ ○ ○ ○ ○ ○ ○
on ov ob nl ni ns nsv cl csv al asv nelv nesv olv osv

Borchia con foro diametro 10 mm.
Cover with 10 mm diameter hole.



03-ACC-249-U

dimensioni
dimensions

ØB H
19 | 7³¹/64 11,5 | 4¹⁷/32

○ ○ ○ ○ ○ ○ ○ ○ ○ ○ ○ ○ ○ ○ ○ ○
on ov ob nl ni ns nsv cl csv al asv nelv nesv olv osv

Borchia per asta diametro 20 mm.
Cover body for 20 mm diameter pole .



03-ACC-251-U

dimensioni
dimensions

ØB H
19 | 7³¹/64 11 | 4²¹/64

○ ○ ○ ○ ○ ○ ○ ○ ○ ○ ○ ○ ○ ○ ○ ○
on ov ob nl ni ns nsv cl csv al asv nelv nesv olv osv

Borchia per asta diametro 20 mm.
Cover body for 20 mm diameter pole .



03-ACC-193-U

dimensioni
dimensions

ØB H
23,5 | 9¹/4 7,5 | 2⁶¹/64

○ ○ ○ ○ ○ ○ ○ ○ ○ ○ ○ ○ ○ ○ ○ ○
on ov ob nl ni ns nsv cl csv al asv nelv nesv olv osv

Borchia con foro diametro 20 mm.
Cover with 10 mm diameter hole.



03-ACC-162-U

dimensioni
dimensions

ØB Ag
9,5 | 3⁴⁷/64 1,5 | 0¹⁹/32

Base in legno per applique:
03-APP-007/008/009/010/011/012/013/014-U.
Wooden base for wall light:
03-APP-007/008/009/010/011/012/013/014-U.

03-ACC-235-U



dimensioni
dimensions

ØB	Ag
10 3 ¹⁵ /16	1,2 0 ¹⁵ /32

Base in legno per applique 03-APP-084-U.
Wooden base for wall light 03-APP-084-U.

03-ACC-126-U



dimensioni
dimensions

ØB	Ag
10,5 4 ⁹ /64	1,5 0 ¹⁹ /32

Base in legno per applique 03-APP-103-U.
Wooden base for wall light 03-APP-103-U.

03-ACC-169-U



dimensioni
dimensions

ØB	Ag
12,5 4 ⁵⁹ /64	1,5 0 ¹⁹ /32

Base in legno per applique 03-APP-106-U.
Wooden base for wall light 03-APP-106-U.

03-ACC-067-U

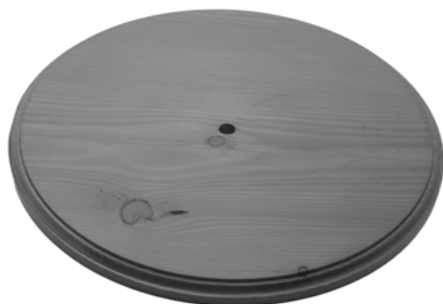

dimensioni
dimensions

ØB	Ag
26 10 ¹⁵ /64	1,8 0 ⁴⁵ /64

Base in legno per plafoniere con diametro max 23,5 cm.
Wooden base for ceiling lights with max. diameter 23.5 cm.

03-ACC-252-U



dimensioni
dimensions

ØB	Ag
32 1 2 ¹⁹ /32	1,8 0 ⁴⁵ /64

Base in legno per plafoniere con diametro max 30 cm.
Wooden base for ceiling lights with max. diameter 30 cm.

03-ACC-142-U

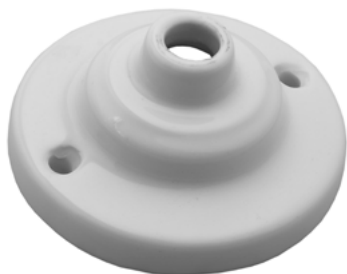

dimensioni
dimensions

ØB	Ag
7 2 ³ /4	3,4 1 ¹¹ /32

Borchia in porcellana per applique 03-APP-010/011/012/014-U.
Porcelain cover body for wall light 03-APP-010/011/012/014-U.

CREDITI:

PROGETTO GRAFICO:

Studio Q-Bic

FOTO:

Francesco Bedini

Alessandro Moggi

Francesco Rastrelli

James Robinson Taylor

FIRENZE
Via dei Serragli, 234 r
50124 Firenze
T. +39 055 2280721

RICCARDO BARTHEL
info@riccardobarthel.it
www.riccardobarthel.it

FORTE DEI MARMI
Via G. Battista Vico, 42
55042 Forte Dei Marmi (LU)
T. +39 0584 787078